

Single Pole (One location) or 3-Way (Multi-location) Magnetic Low-Voltage Dimmer

Cat. No. TGM10-1L (Lighted)
1000VA–120VAC, 60Hz

TOGGLE TOUCH™

INSTALLATION INSTRUCTIONS

WARNINGS & CAUTIONS:

- To be installed and/or used in accordance with appropriate electrical codes and regulations.
- If you are unsure about any part of these instructions, consult a qualified electrician.
- To avoid overheating and possible damage to this device and other equipment, do not install to control a receptacle, fluorescent lighting, a motor- or a transformer-operated appliance.
- Use with magnetic low-voltage transformers, incandescent, or 120V halogen fixtures only. Use a Leviton electronic low-voltage dimmer to control electronic (solid state) low-voltage transformers.
- Total minimum wattage must exceed 40VA.

WARNINGS & CAUTIONS:

- When magnetic low-voltage circuits are operated at a dim level, with all lamps inoperative, excess current may flow through the transformer. To avoid possible transformer failure due to overcurrent, use a transformer that incorporates thermal protection or a fuse at the primary windings.
- Use only one (1) dimmer in a 3- or 4-way circuit. The switch(es) will turn the light on at the brightness level selected at the dimmer.
- Disconnect power at circuit breaker or fuse when servicing fixture.
- Use this device only with copper or copper clad wire. With aluminum wire use only devices marked CO/ALR or CU/AL.
- Recommended to use with non-metallic wallplates.

Tools needed to install your Dimmer:

| | |
|------------------------------|-----------------|
| Slotted/Phillips Screwdriver | Electrical Tape |
| Pliers | Pencil |
| Cutters | Ruler |

Installing Dimmer by itself or with other devices:

If installing Dimmer in a single device application, proceed with the **INSTALLING YOUR DIMMER** section. If installing Dimmer in a multi-device application, proceed as follows:

MULTI-DEVICE APPLICATION

NOTE: You only need to remove side sections if installing with other dimmers or if it does not fit in wall box – not when installing with mechanical switches.

When installing more than one dimmer, the side sections of the mounting strap must be removed. Use pliers to carefully bend side sections back and forth until they break off. The side sections dissipate heat, so removing them requires a derating of the dimmer's capacity (see chart).

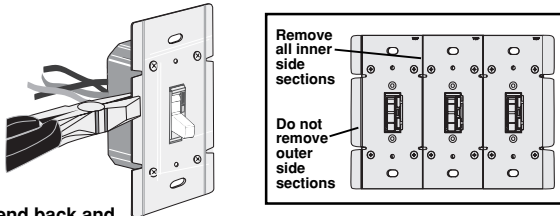

Bend back and forth to remove side section

MAXIMUM LOAD PER DIMMER FOR MULTI-DEVICE

| Cat. No. | Single | Two Devices | More than 2 Devices |
|----------|--------|-------------|---------------------|
| TGM10-1L | 1000VA | 800VA | 700VA |

MAXIMUM BULB WATTAGE

Low-voltage dimmers are rated in Volt-Amps (VA). The maximum bulb wattage is determined by the efficiency of the transformer in the low-voltage lighting system. Transformer efficiencies will vary from different manufacturers; consider 75% efficient as an example. Use the chart to determine maximum bulb wattage for typical transformer efficiency ratings.

MAXIMUM BULB WATTAGE AT 75% EFFICIENCY

| Rating | Single | Two Gang | More than 2 Gang |
|--------|--------|----------|------------------|
| 1000VA | 750W | 600W | 525W |

INSTALLING YOUR DIMMER

NOTE: Use check boxes when Steps are completed.

Step 1 **WARNING:** To avoid fire, shock, or death; **TURN OFF POWER** at circuit breaker or fuse and test that power is off before wiring!

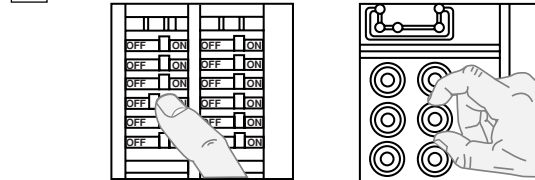

Step 2 **Removing existing switch:** Remove existing wallplate and switch mounting screws. Carefully pull switch from wall box. **DO NOT** remove wires attached to the switch at this time.

Step 3 **Identifying your wiring application (most common):**
NOTE: If the wiring in the wall box does not resemble any of these configurations, consult a qualified electrician.

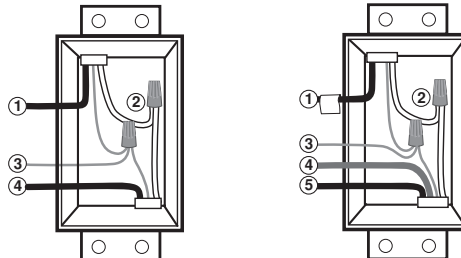

Single-Pole

- Line (Hot)
- Neutral
- Ground
- Load

3-Way

- Line or Load (*See important instruction below*)
- Neutral
- Ground
- First Traveler – note color
- Second Traveler – note color

Step 3 cont'd

IMPORTANT: For 3-Way applications, note that one of the screw terminals from the old switch being removed will usually be a different color (Black) or labeled Common. Tag that wire with electrical tape and identify as the common (Line or Load) in both the dimmer wall box and 3-way wall box.

Step 4 Preparing and connecting wires:

- Make sure that the ends of the wires from the wall box are **straight (cut if necessary)**.
- Remove 5/8" (1.6 cm) of insulation from each wire in the wall box (shown).
- For Single-Pole Application, go to Step 5a.
- For 3-Way Application, go to Step 5b.

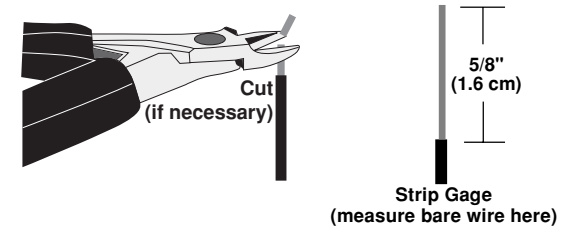

Step 5a Single-Pole Wiring Application:

This wire is used in 3-way installations only. For single pole installations, do not remove this insulating label.

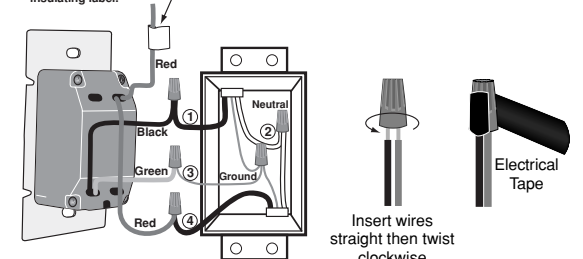

Step 5a Single-Pole Wiring Application:
con't

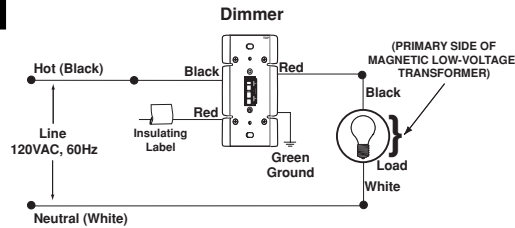

Connect wires per WIRING DIAGRAM as follows:

Screw wire nuts on clockwise making sure no bare conductors show below the wire connectors. Secure each connector with electrical tape.

- Green dimmer Ground lead to Green or bare copper wire in wall box.
- Black dimmer lead to any wall box wire removed from old switch.
- Red dimmer lead without insulating label to remaining wall box wire.
- Remaining Red dimmer lead should have Red insulation label affixed.

NOTE: If insulating label is not affixed to Red lead, use a small wire nut or electrical tape to cap off.

- Proceed to Step 6.

Step 5b con't

Connect wires per WIRING DIAGRAM as follows:

Screw wire nuts on clockwise making sure no bare conductors show below the wire connectors. Secure each connector with electrical tape.

NOTE: Control can be installed on either the Load or Line side of the 3-way circuit.

- Green dimmer Ground lead to Green or bare copper wire in wall box.
- Black dimmer lead to tagged (common) wall box wire identified when removing old switch.
- Remove Red insulating label from Red lead.
- Any Red dimmer lead to any of the remaining wall box wires.
- Remaining Red dimmer lead to remaining wall box wire.

Step 6 Testing your Dimmer prior to completely mounting in wall box:

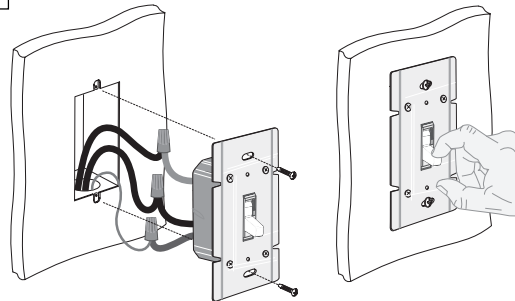

NOTE: Dress wires with a bend as shown in diagram to relieve stress when mounting device.

- Position all wires to provide room in wall box for device.
- Partially secure device using long mounting screws provided.
- Restore power at circuit breaker or fuse.
- Move toggle handle up. Lights should turn ON. If lights do not turn ON, touch top touch pad to brighten the lights. Lights should brighten.

If lights still do not turn ON, refer to the TROUBLESHOOTING section.

Step 7 Dimmer Mounting:
TURN OFF POWER AT CIRCUIT BREAKER OR FUSE.

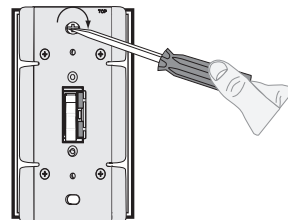

- Installation may now be completed by firmly tightening mounting screws.
- Attach wallplate.

Step 8 Restore Power: Restore power at circuit breaker or fuse. Installation is complete.

OPERATION

NOTE: On the lighted models, indicator light will illuminate when the dimmer is in the OFF position to facilitate access in the dark.

NOTE: If using the dimmer in a 3-way application, the lights will turn ON at brightness set on dimmer's touch pad. The lighting can be controlled from either the dimmer or the switch location.

Touch Pad

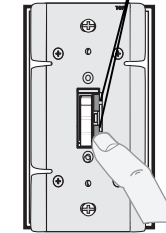

ON/OFF:

Move toggle handle up – Lights will turn ON.

Move toggle handle down – Lights will turn OFF.

BRIGHTEN :

Touch top touch pad – Lights will BRIGHTEN.

DIM:

Touch bottom touch pad – Lights will DIM.

CLEANING:

To clean touch plate, wipe it with a clean damp cloth using clean water only, dry thoroughly.

TROUBLESHOOTING

- Lights Flickering
 - Lamp has a bad connection.
 - Lamp power is less than 40VA.
 - Wires not secured firmly with wire connectors.
- Light does not turn ON and ON/OFF LED does not turn ON
 - Circuit breaker or fuse has tripped.
 - Lamp is burned out.
 - Lamp Neutral connection is not wired.

For non-standard wiring applications, refer to Wire Nut and Conductor Size Chart

| WIRE NUT / # OF CONDUCTOR COMBINATION CHART | |
|---|--|
| 1- #12 w/ 1 to 3 #14, #16 or #18 | |
| 2- #12 w/ 1 or 2 #16 or #18 | |
| 1- #14 w/ 1 to 4 #16 or #18 | |
| 2- #14 w/ 1 to 3 #16 or #18 | |

PRODUCT INFORMATION

- For technical assistance, contact us at **1-800-824-3005**
- Visit our website at www.leviton.com

DI-000-TGM10-02A

LIMITED 5 YEAR WARRANTY AND EXCLUSIONS

Leviton warrants to the original consumer purchaser and not for the benefit of anyone else that this product at the time of its sale by Leviton is free of defects in materials and workmanship under normal and proper use for five years from the purchase date. Leviton's only obligation is to correct such defects by repair or replacement, at its option, if within such five year period the product is returned prepaid, with proof of purchase date, and a description of the problem to **Leviton Manufacturing Co., Inc., Attn: Quality Assurance Department, 59-25 Little Neck Parkway, Little Neck, New York 11362-2591**. This warranty excludes and there is disclaimed liability for labor for removal of this product or reinstallation. This warranty is void if this product is installed improperly or in an improper environment, overloaded, misused, opened, abused, or altered in any manner, or is not used under normal operating conditions or not in accordance with any labels or instructions. **There are no other or implied warranties of any kind, including merchantability and fitness for a particular purpose, but if any implied warranty is required by the applicable jurisdiction, the duration of any such implied warranty, including merchantability and fitness for a particular purpose, is limited to five years. Leviton is not liable for incidental, indirect, special, or consequential damages, including without limitation, damage to, or loss of use of, any equipment, lost sales or profits or delay or failure to perform this warranty obligation.** The remedies provided herein are the exclusive remedies under this warranty, whether based on contract, tort or otherwise.