

DFR Series Smooth Slim Downlight

DATE	PROJECT
TYPE	CATALOG NO.



PRODUCT OVERVIEW

FEATURES

- Ultra slim design for low fixture depth
- Available in 4- and 6-inch diameter models
- Field selectable lumen output and color temperature (CCT)
- Closed cell gasket included for use in wet location environments
- 120V Forward or Reverse Phase Dimming down to 10%
- IC Rated, air-tight, and ENERGY STAR®
- Optional matte black trim ring accessories



PERFORMANCE

Catalog No.	Size	Lumen Output ¹	Input Power	CRI	Color Temperature
DFR40-S1W	4-Inch Round	650/820Lm	8/10W	90+	2700K / 3000K / 3500K / 4000K / 5000K
DFR60-S1W	6-Inch Round	850/1100Lm	10/13W		

1. Values are nominal and vary based on CCT

DFR Series

Smooth Slim Downlight

DATE PROJECT

TYPE CATALOG NO.

TECHNICAL INFORMATION

MATERIAL SPECIFICATIONS

Fixture

Die cast aluminum

Shape

Round

Sizes

Available in 4- and 6-inch diameter models

Finish

Matte white

Lens

Polycarbonate light diffuser for uniform even light distribution

Trim Style

Smooth

LED CHARACTERISTICS

Color Temperature
Selectable CCT: 2700K / 3000K / 3500K / 4000K / 5000K
Factory default set to 2700K
Color Rendering Index (CRI)

90+

R9 Value

High color performance with R9 value greater than 50

Color Consistency
<4-Step MacAdam Ellipse binning to achieve Fixture to Fixture
Color Consistency
Beam Angle

112° (4"), 109° (6")

LED Life

50,000 Hours @ 70% Lumen Maintenance

ELECTRICAL

Driver

Constant Current, Class 2

Power Factor

≥0.9

Input Voltage

120V

Operating Frequency

60Hz

Operating Temperature

-4°F to 104°F (-20°C to 40°C)

Dimmable
120V Forward or Reverse Phase Dimming down to 10%
(See dimmer compatibility list)

COMPLIANCE

cETLus

cETLus listed in accordance with UL 1598 and CSA C22.2 No. 250.0

Environment

Suitable for Wet Locations, covered ceilings

Energy Rating

ENERGY STAR® Certified

Title 24
Complies with Title 24 Part 6 JA8 High Efficacy LED Light
Source Requirements
National Electric Code (NEC)
Suitable for use in clothes closets when installed in accordance with
NEC® 410.16 (A)(1) (C)(3) spacing requirements
IC Rated

Suitable for direct contact with insulation

Air-Tight

Housing certified in accordance with ASTM E283

INSTALLATION

Mounting
No housing required. Two steel tension spring clips secure luminaire
to ceiling. Accommodates ceiling thickness up to 1 inch. New
construction mounting plates are available.
Remote Driver Construction
Steel driver/junction box with captive hinged junction box cover. Easy
to wire 1 in / 1 out (plus ground) applications. Two (2) conduit pry outs
and three (3) poke-in connectors to facilitate wiring.
Template Size

4-inch: 4-1/4"

6-inch: 6-5/16"

5 YEAR LIMITED WARRANTY

Leviton warrants to its customer and the original end user the LED
electronics and components of its properly installed LED products,
to be free of defects in material and workmanship, in normal use, for
a period of five (5) years from the date of shipment by Leviton and
warrants the painted finish for a period of one (1) year from the date of
shipment by Leviton.See the rest of our warranty [here](#).

DFR Series Smooth Slim Downlight

DATE	PROJECT
TYPE	CATALOG NO.

DIMENSIONS

DFR40-S1W

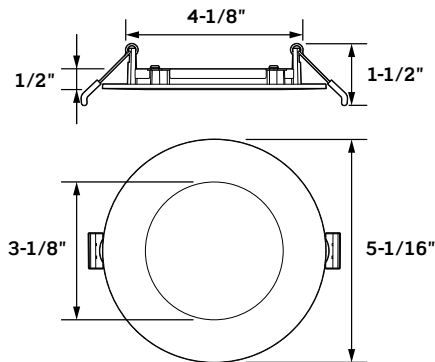

DFR60-S1W

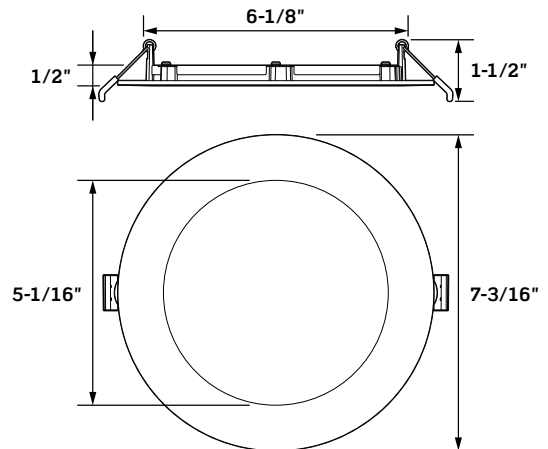

JUNCTION BOX

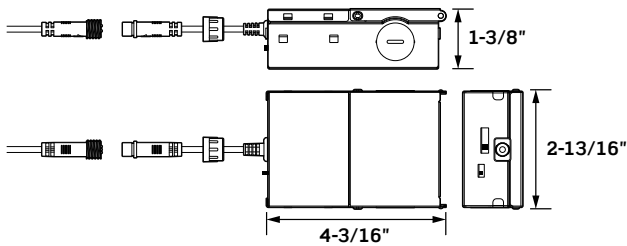

ORDERING INFORMATION

SMOOTH SLIM DOWNLIGHTS



CAT. NO.	Description	UPC Number	Std. Pack
DFR40-S1W	4" Round Smooth Slim Downlight	07847703733 1	12
DFR60-S1W	6" Round Smooth Slim Downlight	07847703734 8	12

ACCESSORIES



CAT. NO.	Description	UPC Number	Std. Pack
DFR4X-T0E	Trim Ring, 4-In Round Smooth DL, Black	07847703735 5	25
DFR6X-T0E	Trim Ring, 6-In Round Smooth DL, Black	07847703736 2	25
DBRCX-H00	4"/6" New Construction Mounting Plate	07847702352 5	15
DBRUX-H00	4"/6"/8" New Construction Mounting Plate	07847702024 1	15

DFR Series Smooth Slim Downlight

DATE	PROJECT
TYPE	CATALOG NO.

DIMMER COMPATIBILITY

The following list of Dimming Controls have gone through testing by Leviton to determine proper operation when paired with the Leviton Smooth Slim Downlights

Supplier	Series	Model No.	Dimming Type	Dimming Range
Leviton	SureSlide	6672	Forward Phase	100-10%
Leviton	SureSlide	6674N	Forward Phase	100-10%
Leviton	SureSlide	66741	Forward Phase	100-10%
Leviton	SureSlide	66DF	Forward Phase	100-10%
Leviton	IllumaTech	IPL06	Forward Phase	100-10%
Leviton	IllumaTech	IPE04	Reverse Phase	100-10%
Leviton	Decora Slide with Lever Edge	ESL01	Forward Phase	100-10%
Leviton	Decora Slide	DSL01	Forward Phase	100-10%
Leviton	Decora Slide	DSE06	Reverse Phase	100-10%
Leviton	Decora Slide	DSM10	Forward Phase	100-10%
Leviton	Decora Digital	DDM06	Forward Phase	100-10%
Leviton	Decora Digital	DDE06	Reverse Phase	100-10%
Leviton	Decora Digital	DDL06-1	Forward Phase	100-10%
Leviton	Decora Digital	DDL06-B	Forward Phase	100-10%
Leviton	Decora Smart Wi-Fi	D36HD	Forward Phase	100-10%
Leviton	Decora Smart Wi-Fi	D26HD	Forward Phase	100-10%
Leviton	Decora Smart Wi-Fi	D2ELV	Phase Selectable (Reverse / Forward)	100-10%
Leviton	Decora Smart Wi-Fi	D2MSD	Forward Phase	100-10%
Leviton	Decora Smart Z-Wave	ZW6HD	Forward Phase	100-10%
Leviton	Decora Evolve	VM2D3	Forward Phase	100-10%
Leviton	Decora Evolve	VMDD3	Forward Phase	100-10%
Leviton	Toggle Slide	TSL01	Forward Phase	100-10%
Leviton	Toggle Slide	TSM10	Forward Phase	100-10%
Leviton	Trimatron Rotary	RDL06	Forward Phase	100-10%
Leviton	Trimatron Rotary	RNL06	Forward Phase	100-10%

DFR Series Smooth Slim Downlight

DATE _____ PROJECT _____

TYPE _____ CATALOG NO. _____

PHOTOMETRICS

DFR40-001-S1W: 4-Inch Round Smooth Slim Downlight

Fixture Delivered Lumens: 867
 Total Watts@120V: 9.9
 Lumens Per Watt: 87.6
 Center Beam Candle Power: 308
 Beam Distribution: 112°
 Spacing Criterion: 1.36
 Color Rendering Index (CRI)¹: 94.8
 Color Temperature (CCT)²: 3026K
 Designed for 50,000 Hour Lamp Life³
 LM-63 Test No. G25112007
 LM-79 Test No. S25081402

Cone of Light		
DISTANCE (FT.)	FOOTCANDLES (FC)	BEAM DIAMETER (FT.)
6 FT	8.5	17.6
8 FT	4.8	23.5
10 FT	3.1	29.4
12 FT	2.1	35.3
14 FT	1.6	41.1
16 FT	1.2	47.0

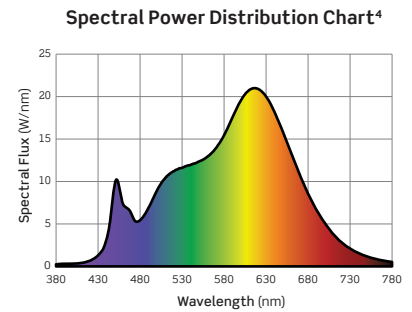
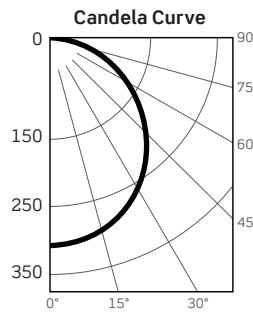

DFR60-001-S1W: 6-Inch Round Smooth Slim Downlight

Fixture Delivered Lumens: 1216
 Total Watts@120V: 12.8
 Lumens Per Watt: 95.0
 Center Beam Candle Power: 438
 Beam Distribution: 109°
 Spacing Criterion: 1.35
 Color Rendering Index (CRI)¹: 94.8
 Color Temperature (CCT)²: 3042K
 Designed for 50,000 Hour Lamp Life³
 LM-63 Test No. G25112002
 LM-79 Test No. S25091102

Cone of Light		
DISTANCE (FT.)	FOOTCANDLES (FC)	BEAM DIAMETER (FT.)
6 FT	12.2	16.8
8 FT	6.8	22.4
10 FT	4.4	28.1
12 FT	3.0	33.7
14 FT	2.2	39.3
16 FT	1.7	44.9

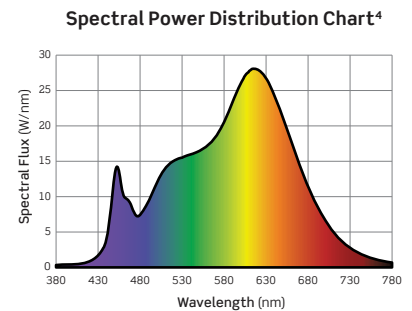
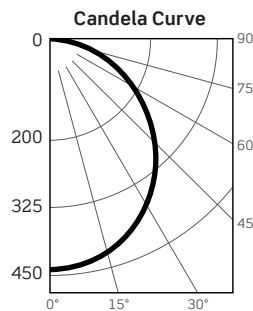

1. Accuracy of Rendering Colors 2. Color Appearance of Light Source 3. Dependent on Surrounding Temperatures 4. Colors Present within the Light Source

PHOTOMETRIC MULTIPLICATION FACTORS

Lumen output values fluctuate based on Color Temperature (CCT), Color Rendering Index (CRI), Trim Finish, and Wattage.

To estimate lumen output of other combinations, multiply the published results by the following factors:

DFR40	
CCT	90+ CRI
2700K	0.96
3000K	1.00
3500K	1.03
4000K	1.04
5000K	1.02

DFR60	
CCT	90+ CRI
2700K	0.96
3000K	1.00
3500K	1.03
4000K	1.04
5000K	1.03

DFR Series Smooth Slim Downlight

DATE	PROJECT
TYPE	CATALOG NO.

PHOTOMETRICS

TM-30 DATA: DFR40-001-S1W 4-Inch Round Smooth Slim Downlight

ANSI/IES TM-30-18 Color Rendition Report Test No. S25081402

R_f	93
R_g	98
CCT(K)	3026K
D_{uv}	0.0007
u^l	0.2494
v^l	0.5219

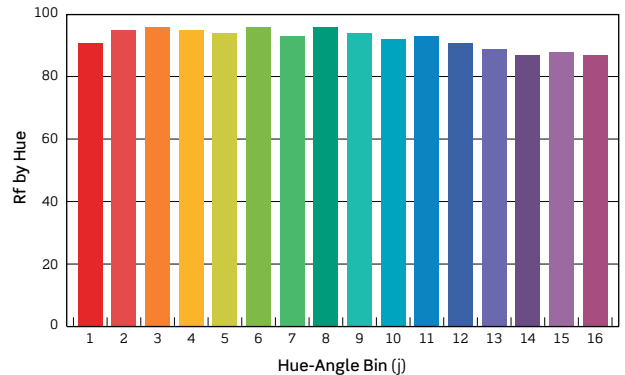
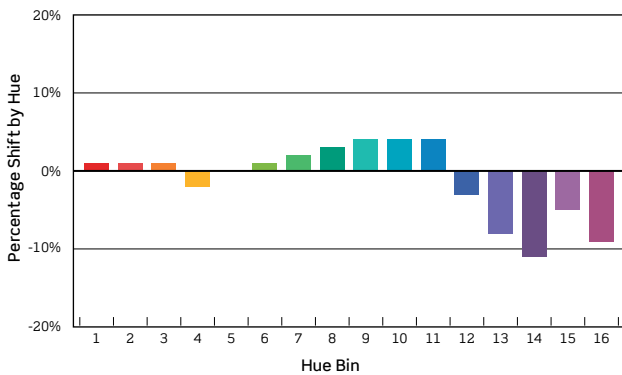
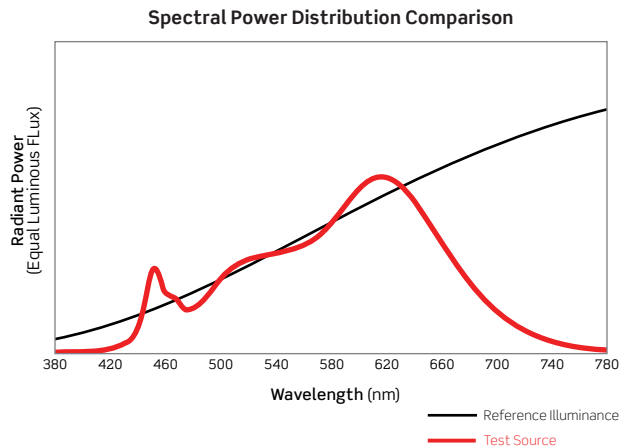
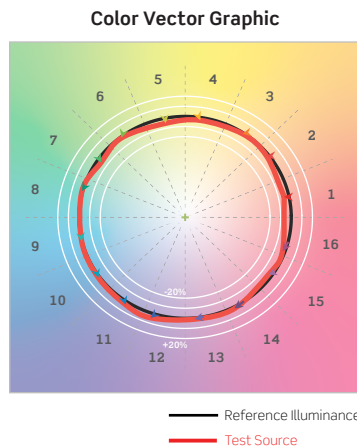

HUE BIN	1	2	3	4	5	6	7	8	9	10	11	12	13	14	15	16
HUE SHIFT	1%	1%	1%	-2%	0%	1%	2%	3%	4%	4%	4%	-3%	-8%	-11%	-5%	-9%
R _f VALUE	91	95	96	95	94	96	93	96	94	92	93	91	89	87	88	87

Colors are for visual orientation purposes only

DFR Series Smooth Slim Downlight

DATE	PROJECT
TYPE	CATALOG NO.

PHOTOMETRICS

TM-30 DATA: DFR60-001-S1W 6-Inch Round Smooth Slim Downlight

ANSI/IES TM-30-18 Color Rendition Report Test No. S25091102

R_f	93
R_g	98
CCT(K)	3042K
D_{uv}	0.0002
u^l	0.2490
v^l	0.5208

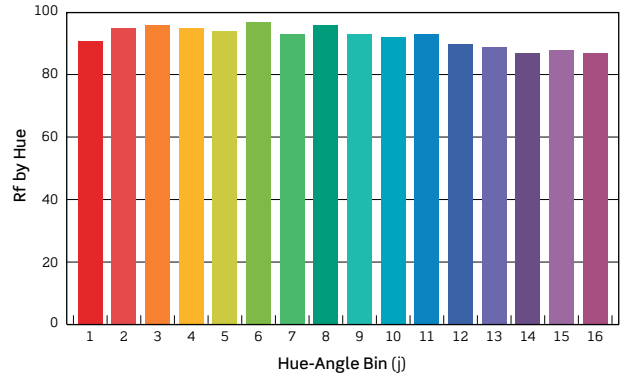
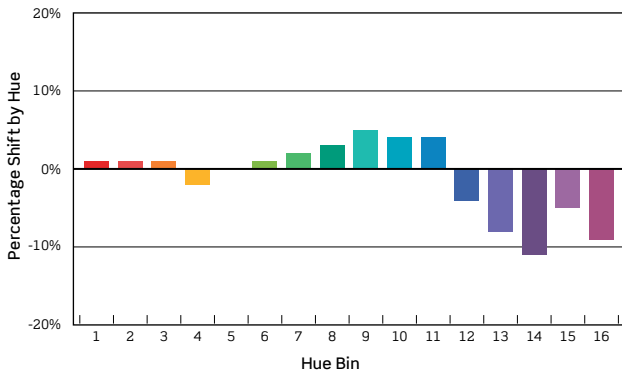
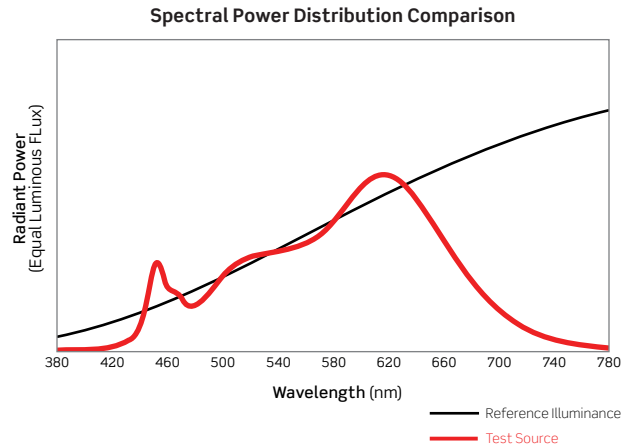
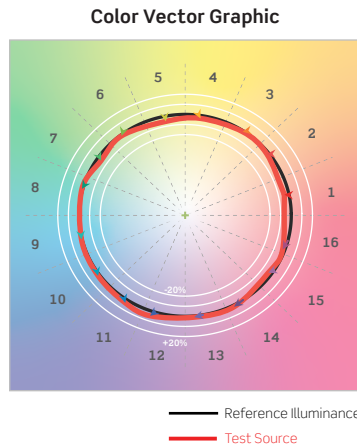

HUE BIN	1	2	3	4	5	6	7	8	9	10	11	12	13	14	15	16
HUE SHIFT	1%	1%	1%	-2%	0%	1%	2%	3%	5%	4%	4%	-4%	-8%	-11%	-5%	-9%
R _f VALUE	91	95	96	95	94	97	93	96	93	92	93	90	89	87	88	87

Colors are for visual orientation purposes only