

Dimensions® D8000 Single-Gang Stations

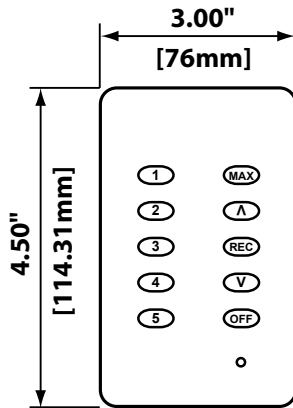

KB102-00X

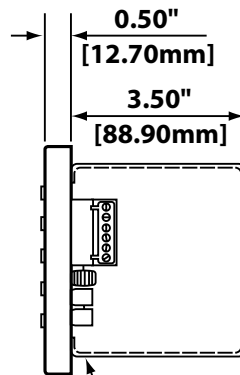

3.50" DEEP WALL BOX
(NOT INCLUDED)

DESCRIPTION

The Dimensions® D8000 Single-Gang stations are part of an advanced family of lighting controls. The distributed processing and network topology of this system brings the power and flexibility of networked computing to the lighting realm. With D8000, lighting projects of very large scale and complexity are readily designed and controlled, enabling total integration of theatrical, architectural and energy management lighting control systems. This highly dependable and capable system is also appropriate for small applications that may benefit from the intuitive operation, flexibility and attractive appearance of the D8000 series.

A complete D8000 lighting control system may also incorporate slider stations, LCD stations, theatrical lighting consoles, dimming racks, relay cabinets, photocells and occupancy sensors. Systems are programmable through the use of an offline, PC-driven editing program. Protocol converters are available to allow communications in Ethernet TCP/IP, DMX512, RS232 and Luma-Net® III.

FEATURES

- Machined from solid Corian for beautiful appearance and extreme durability
- Distributed processing provides enhanced reliability
- Station retains programming information for a minimum of 10 years without power
- Built-in IR receiver on push button stations
- Advanced software readily permits sophisticated join/separate room combining operations
- Available in black and white as standard colors

- Any Corian finish available as a custom
- Six different single-gang stations in one, two, three, five, ten and fifteen button configurations
- Stations with raise/lower feature enable scene light level adjustment without changing programmed preset levels
- Key operated lockout station can be programmed to lock out all stations in the D8000 network
- A/V serial interface stations enable D8000 network to receive RS232 signals from personal computers and A/V equipment

SPECIFICATIONS

- All buttons are programmable and can execute any system function
- Programmable functions include, but are not limited to:
 - "Fade To" Command
 - Personality Change
 - Room Combine
 - Scene Change
 - Snapshot
 - Lock
 - Raise/Lower
 - MAX
- Programmable through Luma-Edit™ PC-based offline editing program
- May address up to 2,048 dimmer channels
- Mechanically captured buttons and sliders to prevent removal or vandalism
- Daylight viewable blue LED button and slider backlights with 20-year minimum life
- Fits in 3.5" deep wall box
- Stations connected in series using Belden cable #9829 or equivalent and two conductors for station power

PRODUCT DATA

D8000 PUSH BUTTON STATIONS

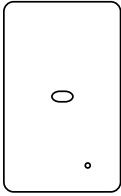

**1 Button
KB01_-00_**

Button Label Options

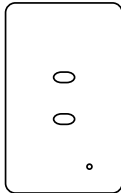

**2 Button
KB02_-00_**

Button Label Options

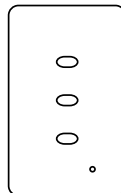
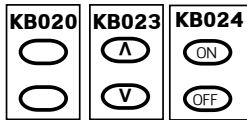

**3 Button
KB03_-00W**

Button Label Options

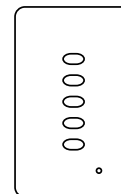
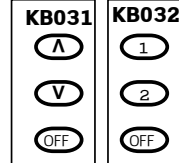

**5 Button
KB05_-00_**

Button Label Options

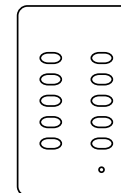
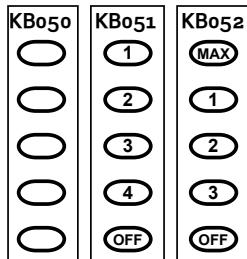

**10 Button
KB10_-00_**

Button Label Options

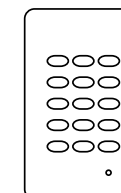
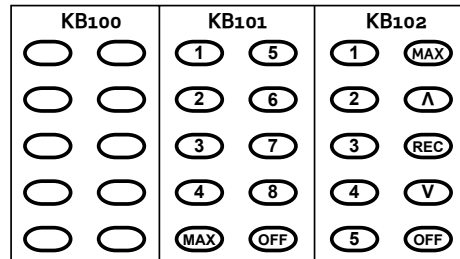

**15 Button
KB15_-00W**

Button Label Options

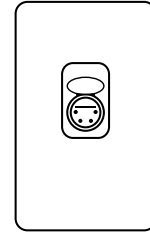
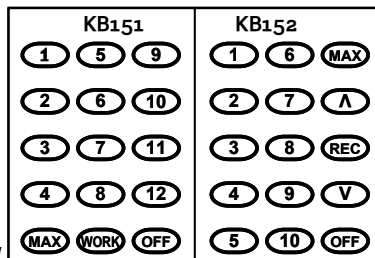

**Remote Portal
KIFC1-00W
connection for
hand-held remote**

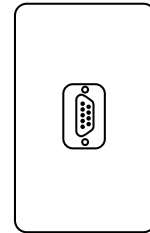

**Luma-Edit
Programming Port
KIFC2-00W
PC interface port
for setup and
programming**

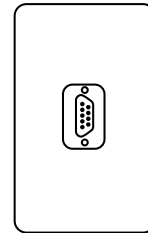

**A/V Serial Inter-
face
KIFC3-00B
Interface for A/V
equipment**

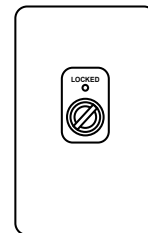

**Key Switch Panels
Single Gang
KLCK1-00W
Key-operated
switch station**

D8000 stations are available as a custom in any color Corian available. Custom engraving is also available. Consult factory for color and engraving options.

TYPICAL APPLICATION

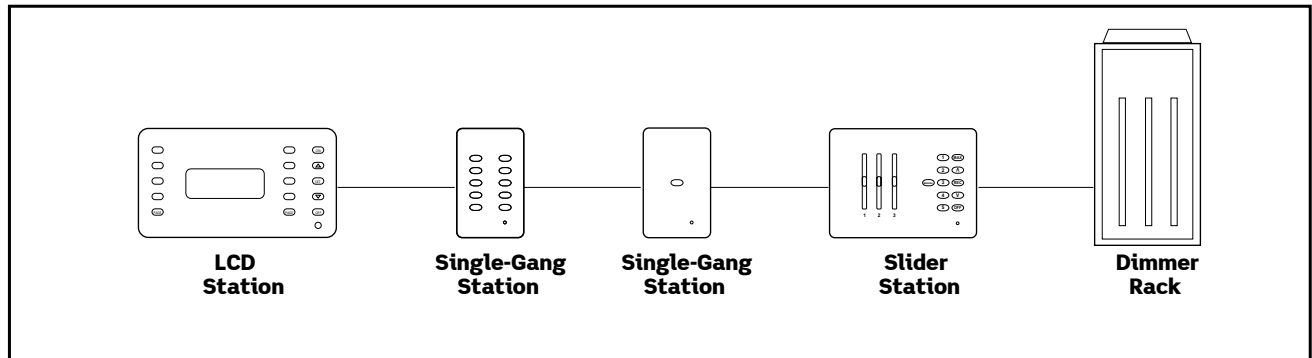

ADVANCED APPLICATION

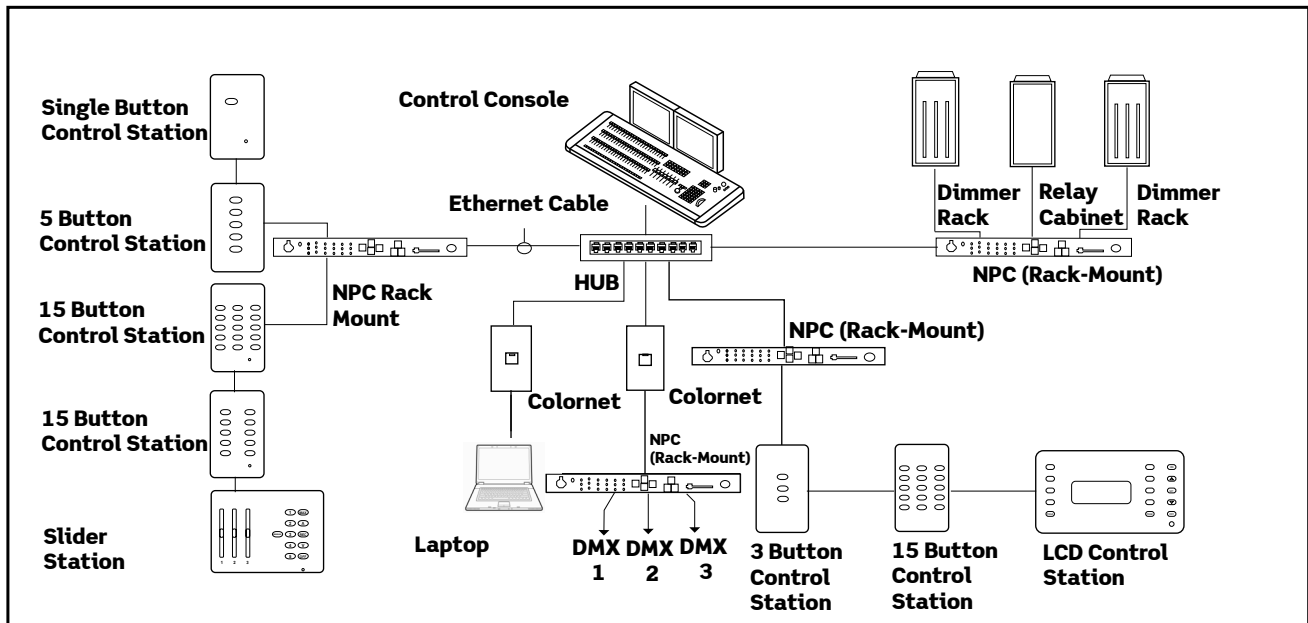

SPECIFICATIONS	
Communication	Communicates via Luma-Net® III over Leviton #WIRLN-500P, Belden #1502R, Belden #9829, or equivalent, RS-485 compatible control cable
Power Input	+10-24Vdc, 50-25mA
Capacity	Up to 32,640 stations on a full network, Up to 128 stations on a sub-network, Up to 2,048 dimmer channels per sub-network
Security	Electronic station lock-out, multiple levels of security passwords
Programming	PC based offline editing via LumaEdit™ software, optional LumaGraphic™ software permits simplified total system programming, including very large scale and sophisticated join/separate room combining operations

ORDERING INFORMATION

CAT. NO.	DESCRIPTION
KB010-00W	D8000 Push Button Station, 1 Button: Black, Color: White
KB010-00B	D8000 Push Button Station, 1 Button: Blank, Color: Black
KB020-00W	D8000 Push Button Station, 2 Buttons: Blank, Color: White
KB023-00W	D8000 Push Button Station, 2 Buttons: Raise, Lower, Color: White
KB024-00W	D8000 Push Button Station, 2 Buttons: On, Off, Color: White
KB024-00B	D8000 Push Button Station, 2 Buttons: On, Off, Color: Black
KB031-00W	D8000 Push Button Station, 3 Buttons: Raise, Lower, & Off, Color: White
KB032-00W	D8000 Push Button Station, 3 Buttons: Presets 1 thru 2 & Off, Color: White
KIFC1-00W	D8000 LCD Remote Portal, Connection for hand-held remote, Color: White
KIFC2-00W	D8000 Luma-Edit Programming Port, PC interface port for setup and programming, Color: White
KIFC3-00B	D8000 A/V Serial Interface, RS-232, Interface for A/V equipment, Color: Black
KLCK1-00W	D8000 Key-operated Switch Station, Color: White
KB050-00W	D8000 Push Button Station, 5 Buttons: Blank, Color: White
KB051-00W	D8000 Push Button Station, 5 Buttons: Presets 1 thru 4 & Off, Color: White
KB051-00B	D8000 Push Button Station, 5 Buttons: Presets 1 thru 4 & Off, Color: Black
KB052-00W	D8000 Push Button Station, 5 Buttons: Presets 1 thru 3, Max & Off, Color: White
KB052-00B	D8000 Push Button Station, 5 Buttons: Presets 1 thru 3, Max & Off, Color: Black
KB100-00W	D8000 Push Button Station, 10 Buttons: Blank, Color: White
KB101-00W	D8000 Push Button Station, 10 Buttons: Presets 1 thru 8, Max, Off, Color: White
KB101-00B	D8000 Push Button Station, 10 Buttons: Presets 1 thru 8, Max, Off, Color: Black
KB102-00W	D8000 Push Button Station, 10 Buttons: Presets 1 thru 5, Raise, Lower, Record, Max & Off, Color: White
KB102-00B	D8000 Push Button Station, 10 Buttons: Presets 1 thru 5, Raise, Lower, Record, Max & Off, Color: Black
KB151-00W	D8000 Push Button Station, 15 Buttons: Presets 1 thru 12, Max, Work & Off, Color: White
KB152-00W	D8000 Push Button Station, 15 Buttons: Presets 1 thru 10, Raise, Lower, Record, Max & Off, Color: White

Leviton Manufacturing Co., Inc. Lighting & Energy Solutions

20497 SW Teton Avenue, Tualatin, OR 97062 • Tel: 1-800-736-6682 • FAX: 503-404-5594 • Tech Line (6:00AM-4:00PM P.S.T. Mon-Fri): 1-800-959-6004

Leviton Manufacturing Co., Inc. Global Headquarters

201 N. Service Rd. Melville, NY 11747-3138 • Tech Line: 1-800-824-3005 • Fax: 1-800-832-9538

Leviton Manufacturing of Canada, Ltd.

165 Hymus Boulevard, Pointe Claire, Quebec H9R 1E9 • Telephone: 1-800-469-7890 • FAX: 1-800-563-1853

Leviton S. de R.L. de C.V.

Lago Tana 43, Mexico DF, Mexico CP 11290 • Tel. (+52) 55-5082-1040 • FAX: (+52) 5386-1797 • www.leviton.com.mx

Visit our Website at: www.leviton.com/les

© 2013 Leviton Manufacturing Co., Inc. All rights reserved. Subject to change without notice.