

Z-MAX™ Digital Switches



DI-000-ZMDSW-00D

WARNINGS AND CAUTIONS:

- TO BE INSTALLED AND/OR USED IN ACCORDANCE WITH APPROPRIATE ELECTRICAL CODES AND REGULATIONS.
- IF YOU ARE NOT SURE ABOUT ANY PART OF THESE INSTRUCTIONS, CONSULT AN ELECTRICIAN.
- DO NOT CONNECT LINE VOLTAGE WIRES TO LOW VOLTAGE TERMINALS.
- FOR THE BEST LAMP LIFE, LAMP MANUFACTURERS RECOMMEND THEIR FLUORESCENT LAMPS SHOULD BE OPERATED AT FULL BRIGHTNESS FOR A MINIMUM OF 100 HOURS BEFORE DIMMING IS PERMITTED. FOR BEST RESULTS, LAMP BRANDS AND TYPES SHOULD NOT BE INTERMIXED ON A CIRCUIT.
- **DISCONNECT POWER** WHEN SERVICING THE DIMMER, FIXTURE OR WHEN CHANGING LAMPS.
- FOR INDOOR USE ONLY.
- TO AVOID FIRE, SHOCK OR DEATH: **TURN OFF POWER** AT MAIN CIRCUIT BREAKER OR FUSE AND TEST THAT THE POWER IS OFF BEFORE WIRING!

INTRODUCTION:

For best results using the Z-MAX™ Digital Switches, follow these recommendations:

1. Plan the system before beginning the installation
2. Terminate the wiring
3. Test the wiring
4. Connect relay cabinets
5. Check voltages
6. Power up the stations
7. Program each station
Assign unique network ID numbers to stations.
Check the proper operation of each station as it is installed when multiple stations are involved.
8. Install all stations

NOTE: If the lighting control fails or becomes sporadic, first check the wiring or network ID.

MINIMUM BACK BOX DIMENSIONS:

- **NEMA (US) markets:** 1 gang device back box, 1-1/2" deep.
- **For IEC (3x3) markets:** 1 gang device back box, min 35mm deep, 47mm preferred.
Minimum vertical clearance 69mm, minimum horizontal clearance 45mm.
Designed for horizontal screw mounting.

TERMINATING THE WIRING:

Luma-Net® III

Control Stations can be located up to 2000 ft. from the dimming cabinet. Luma-Net® is wired Daisy Chained, station to station. For applications where runs become too long, or a star configuration is desired, a Hub can be used. The cable should not pass near any source of electrical noise such as fluorescent circuits or motor wiring. Avoid close proximity to any AC wiring. All control/power wiring must be in conduit.

Luma-Net® Wire Recommendations

Leviton strongly recommends the use of Belden 1502R or 1502P for Luma-Net® wire runs. Other Belden cables, ex: #9829 & 9729, or RS-485 cable compliant with the specifications above, may also be used. Standard voltage drop for DC power systems can be used. Stations require a minimum of +10VDC in order to be effective.

1. Use RS485 compatible cable for communications. It is recommended that a cable with 2 Twisted Pair, 24 AWG (min.), stranded conductors be used. The spare pair is for future uses.
2. Capacitance of wire shall be 15pF/ft. or less.
3. Normal Impedance of wire shall be between 100-120 ohms.
4. Drain/Shields to be tied together, insulated and grounded at one point only.
5. A second pair of stranded wire is required for the power.

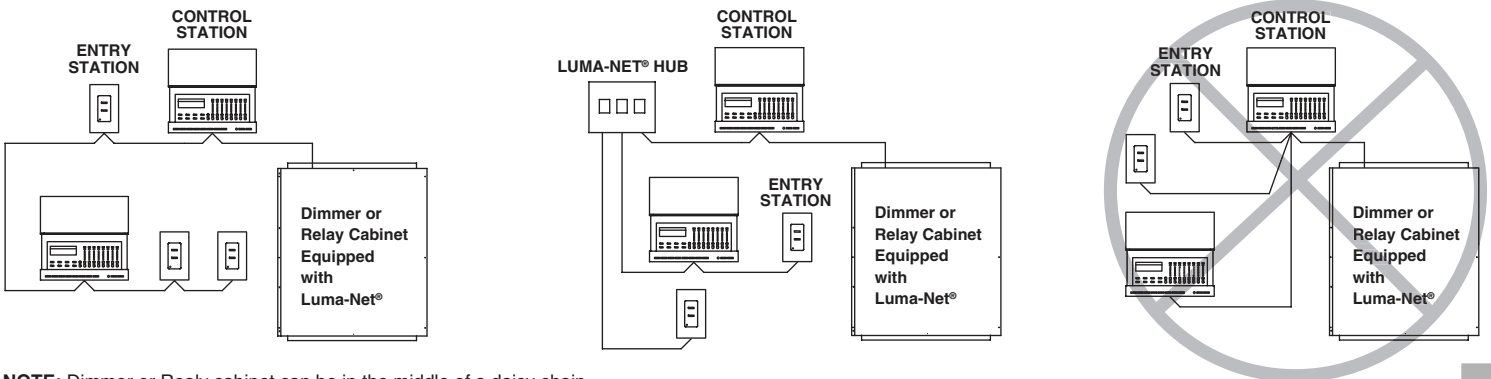

NOTE: Dimmer or Realy cabinet can be in the middle of a daisy chain

NOTE: All control wiring is Class 2.

If a remote DC power supply is used and you have multiple **Luma-Net®** runs, all DC common wires must be joined at the power supply.

At the last control station or dimmer cabinet on both ends of run, a small jumper wire must be run from the terminal labeled "Rem-" to the terminal marked "Term" on that last station. This jumper wire properly terminates the digital communications lines at both ends of the line.

Power Consumption

- Input Power: 24 VDC
- Consumption:

Station	Unit Load Consumption @ 24 VDC 1 Unit Load = 25mA
1 button	0.6
2 button	0.8
3 button	1.0
4 button	1.1
5 button	1.3
6 button	1.0
8 button	1.1
10 button	1.3

Wire the Phoenix/ Luma-Net® Connector

1. Connect leads per wiring diagram (see **Luma-Net® Wire Connections**).
2. Twist strands of each lead tightly (making sure that there are no stray strands) and push firmly into appropriate plug connector location.
3. Tighten the screws on the plug connector-making sure that no bare conductor is showing.
4. Tie the Drain/Shield wires together and insulate using a small piece of heat shrink tubing.
5. Install termination jumpers as required. Remember a termination jumper is required at the two ends of the **Luma-Net®** run.

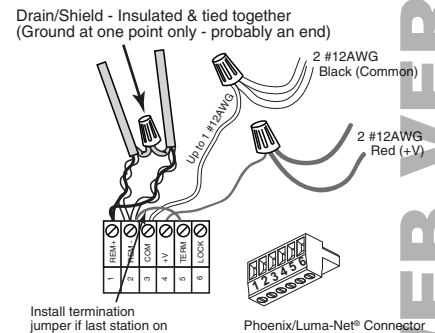

Luma-Net® Wire Connections for runs longer than 1,000 ft.

WEB VERSION

Drain/Shield - Insulated & tied together
(Ground at one point only - probably an end)

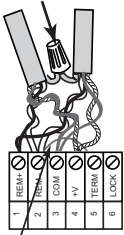

Install termination jumper if last station on

Phoenix/Luma-Net® Connector

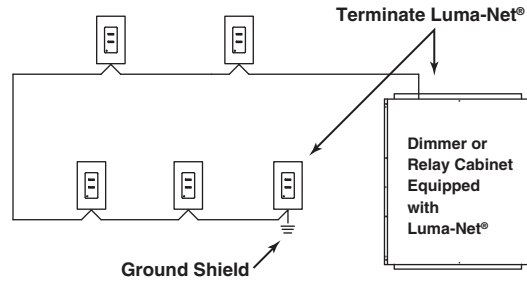

Termination Jumper Locations

Wiring for runs shorter than 1,000 ft.

TESTING THE WIRING:

To assure problem-free start-up, it is important to check the system wiring, prior to hooking up any control stations, for proper connections, shorts and opens. The following procedure is recommended:

Step 1: Test the following wire pairs for shorts at each station location, using an ohmmeter or other continuity tester.

- 1-2 Open
- 2-3 Open
- 3-4 Open

Step 2: Repair any short circuits before continuing.

Step 3: Install wire jumpers, one pair at a time (not supplied) to the Luma-Net® connector on either end of the cable run between pins 1-2, then 2-3, then 3-4.

Step 4: Retest each of the following wire pairs at each connector:

- 1-2 Short
- 2-3 Short
- 3-4 Short

Step 5: Make any necessary repairs and remove wire jumpers before continuing.

STATION ADDRESSING – GENERAL:

Every station needs to be given a unique address between 1 and 127. If a station address is set to Zero it will not participate on the network. The switch is set to the binary representation of the ID number. The binary 1's column is left-most (lever labeled "1"). The switch levers are numbered 1-8, these represent the following:

Lever=Value

- 1=1 2=2
- 3=4 4=8
- 5=16 6=32
- 7=64 8=Not used - Must be OFF

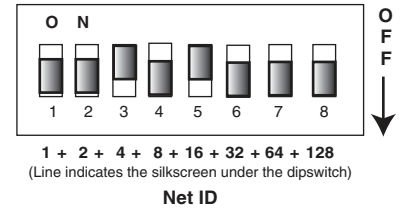

Add the value of each lever in the "ON" position to determine the ID number (decimal form).

For example:

To set the address to 39, the following switches need to be in the "ON" position: 1, 2, 3, 6 = 1+2+4+32=39

ASSIGNING THE STATION:

Determine the stations address and set it on the back of the unit. If there is only one unit in the room or space controlling the same loads, proceed to the Installation Step. Multiple Z-MAX™ digital switches can be slaved back to a Z-MAX™ digital switch, thus mimicking a 3 way or 4 way application and only having to program one switch input at the relay panel. In this case, follow these steps:

To set the remote identification number, and slave it to a master Z-MAX Digital Switch:

1. With the station unplugged, set the remote slave station's DIP switches to the address of the master station that it is to be slaved with.
2. With the station unplugged, **press and hold** the UPPER most LEFT button. This "Init Button" must be continuously held during the next few steps.
3. While holding the button down, **power up** the station by plugging it back in.
4. The **Green** front panel LED's remain dark (**OFF**), while the Red LED on the back turns **ON**. The **Red LED** remains **ON** while the unit waits for 10 seconds.
5. The station will indicate that the ID has been saved/recorded by the **Green** front panel LED's blinking twice and the back **Red LED** turning **OFF**, then **ON**, then **OFF** again.
6. Take your finger off of the "Init Button".
7. Now unplug the unit to end the Slave Node ID configuration programming.
8. With the station unplugged, set the DIP switches to the desired ID number for this particular remote station (every station on the network must have its own unique station number between 1-127).
9. Power up the station by plugging it back in, and it should be ready to operate normally. When the station first powers up under operating conditions, all of the **Green LED's** flash on momentarily and then go off; and the back **Red LED** flashes rapidly until the **Luma-Net®** network becomes stable/operational at which point the back **Red LED** flashes ON/OFF briefly about once per second...sort of a heart beat/normal operation indication.
10. If you've made an error in programming the station's own ID or the Slave ID, the station will flash error codes on all of the LED's (both front panel and back). The following Error Codes are observable. The pattern is blinked and then **repeated** after a pause.
 - a. 1 blink of all LED's= Station Net ID is zero or too high
 - b. 2 blinks of all LED's= 1ST Slave ID is zero or too high
 - c. 3 blinks of all LED's= Both Station Net ID and Slave ID are the same
11. To reprogram the station back to a Master, unplug the connector, set the dip switch to the desired network ID and follow steps 2-7.

INSTALLATION:

Securely mount the entry station using the screws provided. If you are using a screwless snap on plate, remove the center tabs of the strap as shown in Fig. 1.

NOTE: For Cat. Nos. ZMDSW-S1W, -S2W, -S3W, -S4W and -S5W, a 35mm or preferred 47mm deep 2-tab back box is required. Refer to Fig. 2.

PROGRAMMING/OPERATION:

All programming of the Z-MAX digital switches are done at the relay cabinet. Please refer to LIT-ZMAXN-000 for the remainder of the setup and programming.

FIG. 1

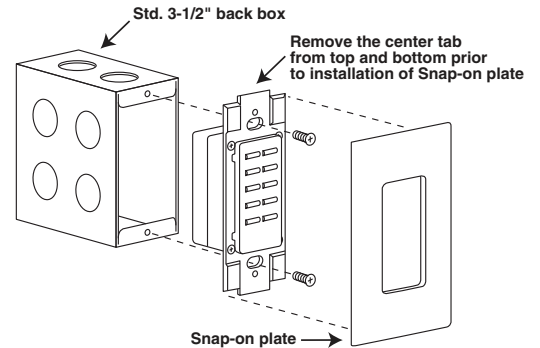
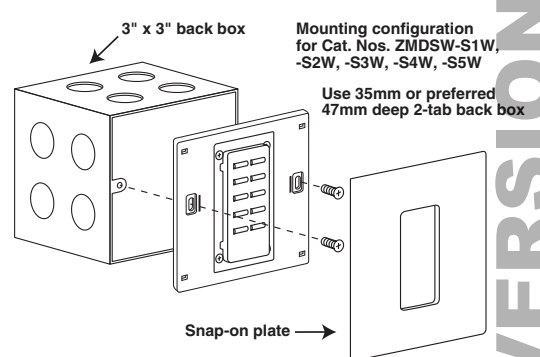

FIG. 2



LIMITED 2 YEAR WARRANTY AND EXCLUSIONS

Leviton warrants to the original consumer purchaser and not for the benefit of anyone else that this product at the time of its sale by Leviton is free of defects in materials and workmanship under normal and proper use for two years from the purchase date. Leviton's only obligation is to correct such defects by repair or replacement, at its option, if within such two year period the product is returned prepaid, with proof of purchase date, and a description of the problem to Leviton Manufacturing Co., Inc., Attn: Quality Assurance Department, 20497 S.W. Teton Ave, Tualatin OR 97062. This warranty excludes and there is disclaimed liability for labor for removal of this product or reinstallation. This warranty is void if this product is installed improperly or in an improper environment, overloaded, misused, opened, abused, or altered in any manner, or is not used under normal operating conditions or not in accordance with any labels or instructions. There are no other or implied warranties of any kind, including merchantability and fitness for a particular purpose, but if any implied warranty is required by the applicable jurisdiction, the duration of any such implied warranty, including merchantability and fitness for a particular purpose, is limited to two years. Leviton is not liable for incidental, indirect, special, or consequential damages, including without limitation, damage to, or loss of use of, any equipment, lost sales or profits or delay or failure to perform this warranty obligation. The remedies provided herein are the exclusive remedies under this warranty, whether based on contract, tort or otherwise.