

Series 4000-K

Compact Modbus Power and Energy Meter

Quick Install Guide
Z206883-0A
05145



20497 SW Teton Avenue, Tualatin, OR 97062
1-503-404-5500
1-800-736-6682
email: lescustomerservice@leviton.com
www.leviton.com

Additional Resources:
For a copy of the full installation guide for this product, visit www.leviton.com.

⚠️ DANGER

HAZARD OF ELECTRIC SHOCK, EXPLOSION, OR ARC FLASH

- Turn off all power supplying equipment before working on or inside the equipment.
- Follow safe electrical work practices. See NFPA 70E in the USA, or applicable local codes.
- This equipment must only be installed and serviced by qualified electrical personnel.
- Read, understand and follow the instructions before installing this product.
- Product may use multiple voltage/power sources. Be sure all sources of power have been disconnected before servicing.
- Use a properly rated voltage sensing device to confirm power is off.
- DO NOT DEPEND ON THIS PRODUCT FOR VOLTAGE INDICATION
- Only install this product on insulated conductors.

Failure to follow these instructions will result in death or serious injury.

A qualified person is one who has skills and knowledge related to the construction and operation of this electrical equipment and the installation, and has received safety training to recognize and avoid the hazards involved. NEC2011 Article 100
No responsibility is assumed by Leviton for any consequences arising out of the use of this material.

CAUTION

- This product is not intended for life or safety applications.
- Do not install this product in hazardous or classified locations.
- The installer is responsible for conformance to all applicable codes.
- Mount this product inside a suitable fire and electrical enclosure.

Provide a disconnect device to disconnect the meter from the supply source. Place this device in close proximity to the equipment and within easy reach of the operator, and mark it as the disconnecting device. The disconnecting device shall meet the relevant requirements of IEC 60947-1 and IEC 60947-3 and shall be suitable for the application. In the US and Canada, disconnecting fuse holders can be used. Provide overcurrent protection and disconnecting device for supply conductors with approved current limiting devices suitable for protecting the wiring. If the equipment is used in a manner not specified by the manufacturer, the protection provided by the device may be impaired.

FCC PART 15 INFORMATION
NOTE: This equipment has been tested by the manufacturer and found to comply with the limits for a class B digital device, pursuant to part 15 of the FCC Rules. These limits are designed to provide reasonable protection against harmful interference when the equipment is operated in a residential environment. This equipment generates, uses, and can radiate radio frequency energy and, if not installed and used in accordance with the instruction manual, may cause harmful interference to radio communications. This device complies with part 15 of the FCC Rules. Operation is subject to the following two conditions:
(1) This device may not cause harmful interference, and
(2) this device must accept any interference received, including interference that may cause undesired operation.
Modifications to this product without the express authorization of the manufacturer nullify this statement.

For the complete safety information for this product, see the full installation guide at www.leviton.com

For use in a Pollution Degree 2 or better environment only. A Pollution Degree 2 environment must control conductive pollution and the possibility of condensation or high humidity. Consider the enclosure, the correct use of ventilation, thermal properties of the equipment, and the relationship with the environment.
Installation category: CAT II or CAT III

Specifications

Measurement Accuracy:	IEC 62053-22 Class 0.5S, ANSI C12.20 0.5%
Real Power and Energy	
Input Voltage Characteristics:	Minimum 90V _{L-N} (156V _{L-L}) for stated accuracy; UL Maximums: 600V _{L-L} (347V _{L-N}); CE Maximum: 300V _{L-N}
Measured AC Voltage	2.5 MΩ _{L-N} / 5 MΩ _{L-L}
Impedance	
Frequency Range	45 to 65 Hz
Input Current Characteristics:	
Measurement Input Range	0 to 0.333VAC or 0 to 1.0VAC (+20% over-range)
Impedance	10.6kΩ (1/3 V mode) or 32.1kΩ (1 V mode)
Control Power:	
AC	5VA max.; 90V min. UL Maximums: 600V _{L-L} (347V _{L-N}) CE Maximum: 300V _{L-N}
DC*	3W max.; UL and CE: 125 to 300VDC
Ride Through Time	100 msec at 120VAC
Mechanical Characteristics:	
IP Degree of Protection (IEC 60529)	IP40 front display; IP20 Meter
Terminal Block Screw Torque	0.37 ft-lb (0.5 N-m) nominal/0.44 ft-lb (0.6 N-m) max.
Terminal Block Wire Size	24 to 14 AWG (0.2 to 2.1 mm ²)
Rail	T35 (35 mm) DIN Rail per EN50022
Operating Conditions:	
Operating Temperature	-30° to 70°C (-22° to 158°F)
Storage Temperature	-40° to 85°C (-40° to 185°F)
Humidity Range	<95% RH (non-condensing)
Altitude of Operation	3 km max.
Metering Category:	
North America	CAT III; for distribution systems up to 347 V _{L-L} /600VAC _{L-L}
CE	CAT III; for distribution systems up to 300 V _{L-N}
Dielectric Withstand	Per UL 508, EN61010
Conducted and Radiated Emissions	FCC part 15 Class B, EN55011/EN61000 Class B (residential and light industrial)
Conducted and Radiated Immunity	EN61000 Class A (heavy industrial)
Agency Approvals:	
US and Canada (cULus)	UL508 (open type device)/CSA 22.2 No. 14-05
Europe (CE)	EN61010-1

* External DC current limiting is required, see fuse recommendations.

Dimensions

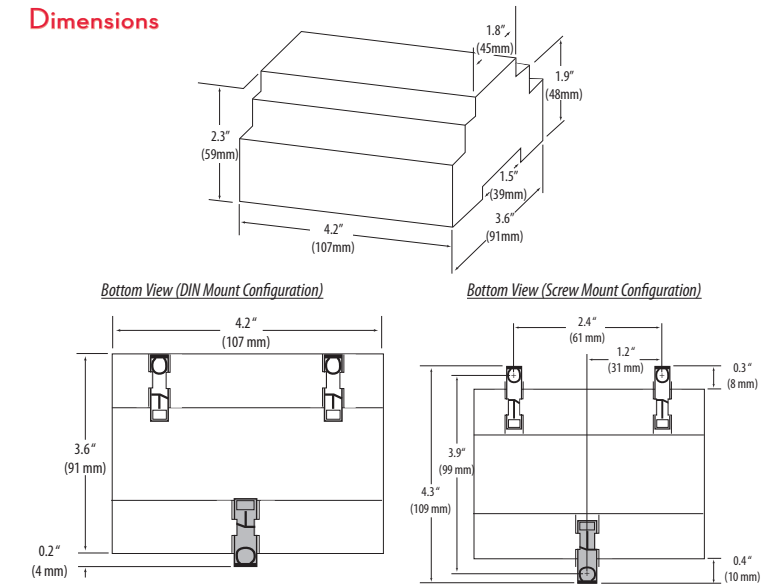

Product Identification

Series 4000-K Unidirectional metering, Modbus full data set, pulse and alarm outputs.

Installation

- WARNING: TO AVOID FIRE, SHOCK, OR DEATH, disconnect power prior to installation.**
 - Reinstall any covers that are displaced during the installation before powering the unit.
 - Mount the meter in an appropriate electrical enclosure near equipment to be monitored.
- Do not install on the load side of a Variable Frequency Drive (VFD).

The meter can be mounted in two ways: on standard 35 mm DIN rail or screw-mounted to the back of the enclosure.

A. DIN Rail Mounting

- Attach mounting clips to the underside of the housing by sliding them into the slots from the inside. The stopping pegs must face the housing, and the outside edge of the clip must be flush with the outside edge of the housing.
- Snap the clips onto the DIN rail. See diagram of the underside of the meter.
- To reduce horizontal shifting across the DIN rail, use two end stop clips.

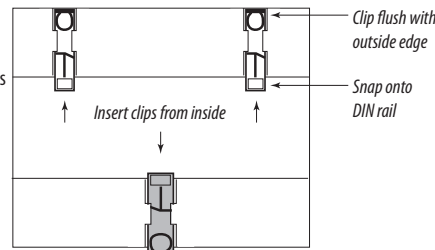

B. Screw Mounting

- Attach the mounting clips to the underside of the housing by sliding them into the slots from the outside. The stopping pegs must face the housing, and the screw hole must be exposed on the outside of the housing.
- Use three #8 screws (not supplied) to mount the meter to the back of the enclosure. See diagram of the underside of the meter.

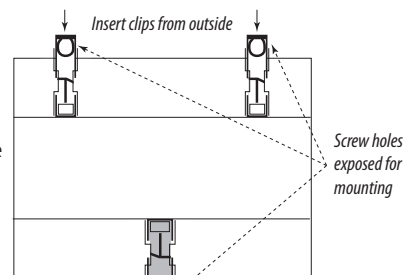

Supported System Types

The meter has a number of different possible system wiring configurations (see Wiring Diagrams, page 9-10). To configure the meter, set the System Type via the User Interface, Modbus register 130. The System Type tells the meter which of its current and voltage inputs are valid, which are to be ignored, and if neutral is connected. Setting the correct System Type prevents unwanted energy accumulation on unused inputs, selects the formula to calculate the Theoretical Maximum System Power, and determines which phase loss algorithm is to be used. The phase loss algorithm is configured as a percent of the Line-to-Line System Voltage (except when in System Type 10) and also calculates the expected Line to Neutral voltages for system types that have Neutral (12 & 40).
Values that are not valid in a particular System Type will display as "----" on the User Interface or as QNAN in the Modbus registers.

	CTs		Voltage Connections			System Type		Phase Loss Measurements			Wiring Diagram
Number of wires	Qty	ID	Qty	ID	Type	Modbus Register 130	User Interface: SETUP> S SYS	VLL	VLN	Balance	Diagram number
Single-Phase Wiring											
2	1	A	2	A, N	L-N	10	1L + 1n		AN		1
2	1	A	2	A, B	L-L	11	2L	AB			2
3	2	A, B	3	A, B, N	L-L with N	12	2L + 1n	AB	AN, BN	AN-BN	3
Three-Phase Wiring											
3	3	A, B, C	3	A, B, C	Delta	31	3L	AB, BC, CA		AB-BC-CA	4
4	3	A, B, C	4	A, B, C, N	Grounded Wye	40	3L + 1n	AB, BC, CA	AN, BN, CN	AN-BN-CN & AB-BC-CA	5, 6

To avoid distortion, use parallel wires for control power and voltage inputs.

The following symbols are used in the wiring diagrams on the following pages.

Symbol	Description
	Voltage Disconnect Switch
	Fuse (Installer is responsible for ensuring compliance with local requirements. No fuses are included with the meter.)
	Earth ground
	Current Transducer
	Potential Transformer
	Protection containing a voltage disconnect switch with a fuse or disconnect circuit breaker. The protection device must be rated for the available short-circuit current at the connection point.

CAUTION

RISK OF EQUIPMENT DAMAGE

- This product is designed only for use with 1V or 0.33V current transducers (CTs).
- DO NOT USE CURRENT OUTPUT (e.g. 5A) CTs ON THIS PRODUCT.
- Failure to follow these instructions can result in overheating and permanent equipment damage.

Product Diagram

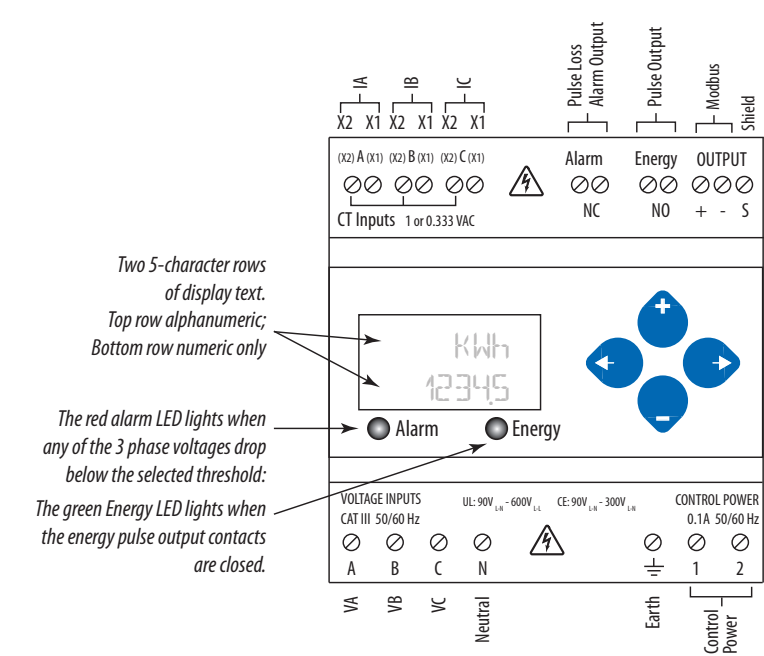

Wiring

⚠ WARNING ⚠

RISK OF ELECTRIC SHOCK OR PERMANENT EQUIPMENT DAMAGE

CT negative terminals are referenced to the meter's neutral and may be at elevated voltages

- Do not contact meter terminals while the unit is connected
- Do not connect or short other circuits to the CT terminals

Failure to follow these instructions may cause injury, death or equipment damage.

For all Series 4000 meters, CTs are NOT polarity sensitive. No need to observe orientation.

Diagram 1: 1-Phase Line-to-Neutral 2-Wire System 1 CT

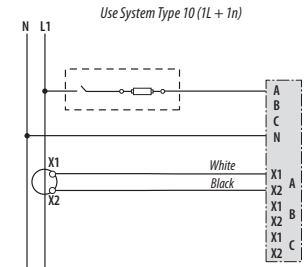

Diagram 2: 1-Phase Line-to-Line 2-Wire System 1 CT

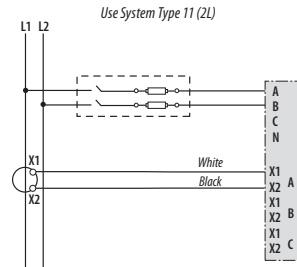

Diagram 3: 1-Phase Direct Voltage Connection 2 CT

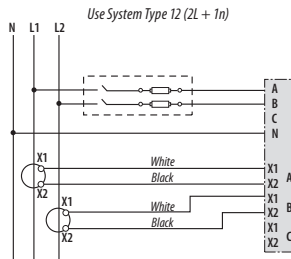
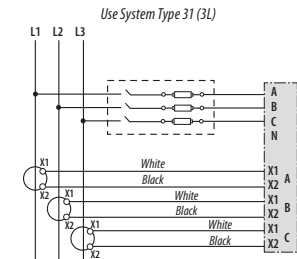

Diagram 4: 3-Phase 3-Wire 3 CT no PT



Page 9

Diagram 5: 3-Phase 4-Wire Wye Direct Voltage Input Connection

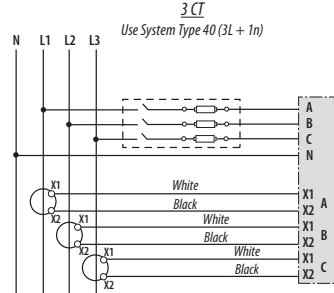
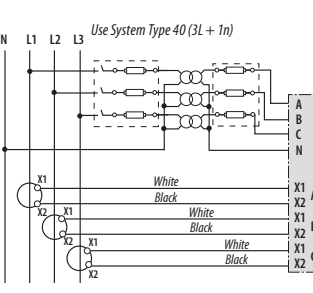

Diagram 6: 3-Phase 4-Wire Wye Connection 3 CT 3 PT



Page 10

Control Power

Direct Connect Control Power (Line to Line)

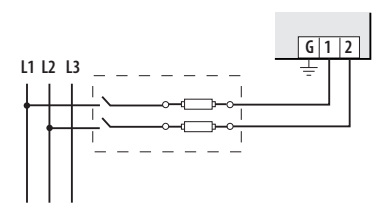

Line to Line From 90 VAC to 600 VAC (UL). In UL installations the lines may be floating (such as a delta). If any lines are tied to an earth (such as a corner grounded delta), see the Line to Neutral installation limits. In CE compliant installations, the lines must be neutral (earth) referenced at less than 300 VAC_{UL}.

Direct Connect Control Power (Line to Neutral)

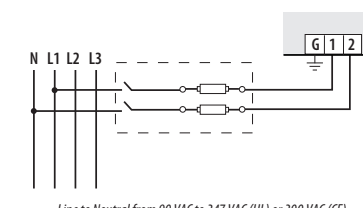

Line to Neutral from 90 VAC to 347 VAC (UL) or 300 VAC (CE)

Direct Connect Control Power (DC Control Power)

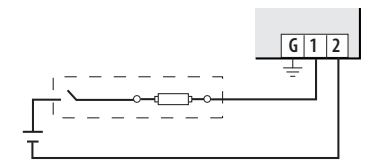

DC Control Power from 125 VDC to 300 VDC (UL and CE max.)

Control Power Transformer (CPT) Connection

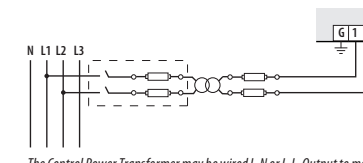

The Control Power Transformer may be wired L-N or L-L. Output to meet meter input requirements

Fuse Recommendations:

Keep the fuses close to the power source (obey local and national code requirements).

For selecting fuses and circuit breakers, use the following criteria:

- Select current interrupt capacity based on the installation category and fault current capability.
- Select over-current protection with a time delay.
- Use a voltage rating sufficient for the input voltage applied.
- Provide overcurrent protection and disconnecting means to protect the wiring. For DC installations, provide external circuit protection. Suggested: 0.5A, time delay fuses rated for DC operation at or above the supply voltage.
- Use the earth connection (G) for electromagnetic compatibility (EMC), not a protective earth ground.

Page 11

Solid State Pulse Outputs

The Series 4000 has one normally open (N.O.) KY Form A output and one normally closed (N.C.) output. One is dedicated to energy (Wh), and the other to Alarm.

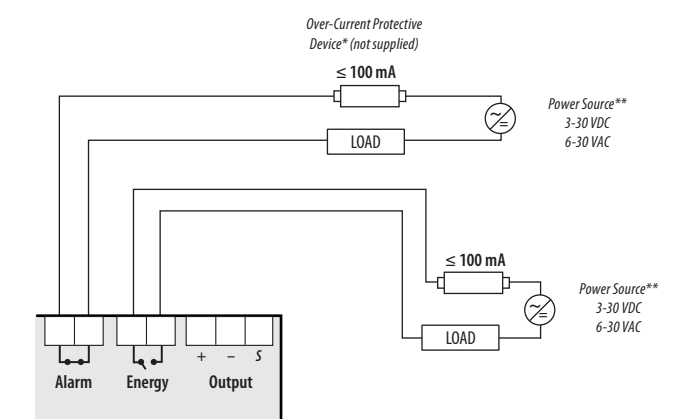

The solid state pulse outputs are rated for 30 VAC/DC nom.

Maximum load current is 100 mA at 25°C. Derate 0.56mA per °C above 25°C (e.g. 86 mA@50°C).

* The over-current protective device must be rated for the short circuit current at the connection point.

** All pulse outputs and communication circuits are only intended to be connected to non-hazardous circuits (SELV or Class 2). Do not connect to hazardous voltages.

Page 12

RS-485 Communications

Daisy-chaining Devices to the Power Meter

The RS-485 slave port allows the power meter to be connected in a daisy chain with up to 63 2-wire devices. In this bulletin, communications link refers to a chain of devices that are connected by a communications cable.

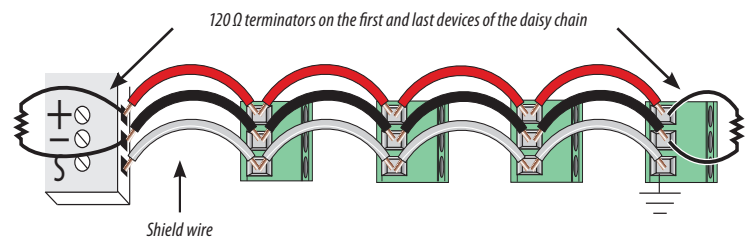

Notes:

- The terminal's voltage and current ratings are compliant with the requirements of the EIA RS-485 communications standard.
- The RS-485 transceivers are 1/4 unit load or less.
- RS-485+ has a 47 kΩ pull up to +5V, and RS-485- has a 47 kΩ pull down to Shield (RS-485 signal ground).
- Wire the RS-485 bus as a daisy chain from device to device, without any stubs. Use 120 Ω termination resistors at each end of the bus (not included).
- Shield is not internally connected to Earth Ground.
- Connect Shield to Earth Ground somewhere on the RS-485 bus (only at one point).

For all terminals on Series 4000 meters:

- When tightening terminals, apply the correct torque: 0.37-0.44 ft-lb (0.5-0.6 N-m).
- Use 14-24 gauge (2.1-0.2 mm²) wire.

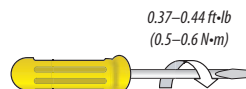

Page 13

Display Screen Diagram

LCD Screen:

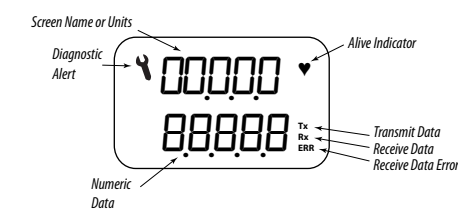

Buttons:

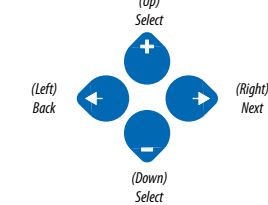

Initial Setup Instructions

Use this section to enter:

- Modbus communication parameters
- CT (Current Transducer) output voltage and input current ranges
- The service type to be monitored

These instructions assume the meter is set to factory defaults. If it has been previously configured, all optional values should be checked. For more options (i.e., potential transformer ratios, etc.) and the full setup instructions, see the full installation guide for the specific model at www.leviton.com.

A. To Navigate to the Setup screens:

- Press **+** or **-** repeatedly until **SETUP** screen appears.
- Press **→** to get to the **PARAM** screen.
- Press **→** to move through the digits. Use the **+** or **-** buttons to enter your password (the default is **0000**).
- Press **→** to move to the first Setup screen (**SCM**).
- Use **+** or **-** to select the parameter screen you want to set.
- After you set the parameters you want, use **+** or **-** to select the next Setup screen or **→** to exit the Setup screens (return to **SETUP**).

Page 14

B. To Enter Modbus communication parameters:

- Navigate to the **SCM** (set communications) Setup screen (see section A above).
- Press **→** to go to the **ADDR** screen and through the address digits. Use **+** or **-** to select the Modbus address (default is **001**).
- Press **→** to accept the value and go to the **BAUD** screen. Use **+** or **-** to select the baud rate (default is **19200**).
- Press **→** to go to the **PAR** screen. Use **+** or **-** to select the parity (default is **NONE**).
- Press **→** to go back to the **SCM** screen.

D. To Enter the CT (Current Transducer) output voltage and input current ranges:

- Navigate to the **SCCT** (Set Current Transducer) Setup screen (see section A above).
- Press **→** to go to the **CT V** screen. Use **+** or **-** to select the voltage mode Current Transducer output voltage (default is **100**).
- Press **→** to go to the **CT S2** screen and through the digits. Use **+** or **-** to select the CT size in amps (default is **100**).
- Press **→** to accept the value and go back to the **SCCT** screen.

E. To Enter the service type to be monitored:

- Navigate to the **SSYS** (Set System) Setup screen (see section A above).
- Press **→** to go to the **SSYSM** screen. Use **+** or **-** to select the configuration (see wiring diagrams - default is **3L-1N**).
- Press **→** to go back to the **SSYS** screen.

Page 15

China RoHS Compliance Information (EFUP Table)

产品中有毒有害物质或元素的名称及含量Substances						
部件名称	铅 (Pb)	汞 (Hg)	镉 (Cd)	六价铬 (Cr (VI))	多溴联苯 (PBB)	多溴二苯醚 (PBDE)
电子线路板	X	0	0	0	0	0
0 = 表示该有毒有害物质在该部件所有均质材料中的含量均在 SJ/T11363-2006 标准规定的限量要求以下。 X = 表示该有毒有害物质至少在该部件的某一均质材料中的含量超出SJ/T11363-2006标准规定的限量要求。						
Z000057-0A						

For technical support, contact Leviton at 800-959-6004, or via email at lestechnsupport@leviton.com

©2014 Leviton

Page 16