

- Leviton's Decora® style design
- Slide control for easy and precise operation
- Separate preset ON/OFF rocker switch and minimum brightness adjustment

INSTALLATION INSTRUCTIONS

WARNING: TO BE INSTALLED AND/OR USED IN ACCORDANCE WITH APPROPRIATE ELECTRICAL CODES AND REGULATIONS.
WARNING: IF YOU ARE NOT SURE ABOUT ANY PART OF THESE INSTRUCTIONS, CONSULT A QUALIFIED ELECTRICIAN.
WARNING: TO AVOID OVERHEATING AND POSSIBLE DAMAGE TO THIS DEVICE AND OTHER EQUIPMENT, DO NOT INSTALL TO CONTROL A RECEPTACLE, FLUORESCENT LIGHTING, A MOTOR- OR A TRANSFORMER-OPERATED APPLIANCE.

OTHER CAUTIONS:

1. EVERY LEVITON RENOIR™ DIMMER FITS STANDARD 2" x 3" OUTLET BOX.
2. DIMMER MUST BE MOUNTED VERTICALLY FOR PROPER HEAT DISSIPATION.
3. FOR 3-WAY APPLICATIONS, USE ONLY ONE (1) DIMMER PER LOAD. THE REMAINING 3-WAY SWITCH WILL TURN LIGHT ON AT THE BRIGHTNESS LEVEL SELECTED AT THE DIMMER.
4. DISCONNECT POWER WHEN SERVICING FIXTURE.
5. USE THIS DEVICE ONLY WITH COPPER OR COPPER CLAD WIRE. WITH ALUMINUM WIRE USE ONLY DEVICES MARKED CO/ALR OR CU/AL.

MULTI-GANG INSTALLATION:

WARNING: DO NOT GANG DIMMERS VERTICALLY (ONE DIRECTLY ABOVE ANOTHER).

Cat. No. 80800: Derating is not necessary when both sets of fins are removed.

Cat. No. 81000: The dimmer must be derated to 800W when both sets of fins are removed. If no fins are removed, derating is not necessary.

Cat. No. 81500: The dimmer must be derated to 1300W when both sets of fins are removed. If no fins are removed, derating is not necessary.

Cat. No. 82000: The dimmer must be derated to 1800W when both sets of fins are removed. If no fins are removed, derating is not necessary.

Leviton Renoir™ dimmers have anodized aluminum fins that dissipate heat generated by proper functioning of the dimmers. If lack of space dictates fin removal, do so **ONLY** at the break-off points shown in Fig. 2. Any other kind of fin removal will be considered as an alteration of the unit and will thus **VOID** the warranty, stated or implied.

DOUBLE GANGING: Break off the right side set of fins from the left unit and the left side set of fins from the right unit. Trim off the inside section of each cover plate by cutting along the mark inside the plate with a sharp blade.

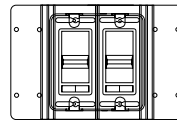

Double Ganging - Narrow Dimmers

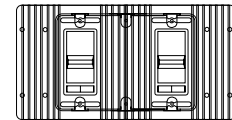

Double Ganging - Wide Dimmers

TRIPLE GANGING: Break off the right side set of fins from the left unit, the left side set of fins from the right side unit, and both sets of fins from the center unit. Trim off the inside section of the end cover plates and both sections from the center cover plate, using a sharp blade.

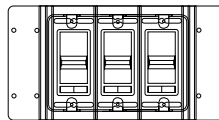

Triple Ganging - Narrow Dimmers

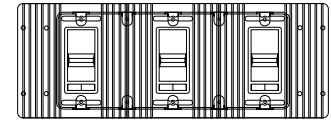

Triple Ganging - Wide Dimmers

To gang more than three units, follow instructions for center unit of triple gang installation.

TO INSTALL:

1. **WARNING:** TO AVOID FIRE, SHOCK, OR DEATH; **TURN OFF POWER AT CIRCUIT BREAKER OR FUSE AND TEST THAT POWER IS OFF BEFORE WIRING!**
2. Remove existing wall plate and switch, if applicable.
3. Remove 3/4" (1.9 cm) of insulation from each circuit conductor. Make sure the ends of wires are straight.
4. Connect wires per **WIRING DIAGRAM** as follows: Twist strands of each lead tightly together and, with circuit conductors, push firmly into appropriate wire connector. Screw connectors on clockwise making sure no bare conductors show below the wire connectors. Secure each connector with electrical tape.

Figure 1 - Dimmer Functions

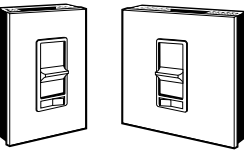
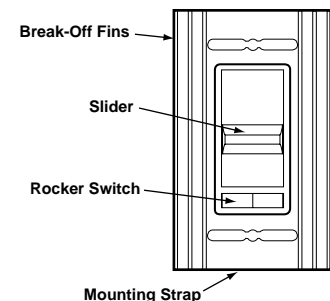

Cat. Nos.
80800
81000

Cat. Nos.
81500
82000

RENOIR™

Single Pole (One location) or
3-Way (Multi-location)
120VAC, 60Hz

Slide Dimmer
Incandescent

Cat. No. 80800, 800W
Cat. No. 81000, 1000W
Cat. No. 81500, 1500W
Cat. No. 82000, 2000W

INSTALLATION INSTRUCTIONS



PK-92955-20-00-0A

LIMITED 2 YEAR WARRANTY AND EXCLUSIONS

Leviton warrants to the original consumer purchaser and not for the benefit of anyone else that this product at the time of its sale by Leviton is free of defects in materials and workmanship under normal and proper use for two years from the purchase date. Leviton's only obligation is to correct such defects by repair or replacement, at its option, if within such two year period the product is returned prepaid, with proof of purchase date, and a description of the problem to Leviton Manufacturing Co., Inc., Attn: Quality Assurance Department, 59-25 Little Neck Parkway, Little Neck, New York 11362-2591 (In Canada send to Leviton Mfg. of Canada Ltd., 165 Hymus Blvd., Point Claire, (Quebec), Canada H9R 1E9). This warranty excludes and there is disclaimed liability for labor for removal of this product or reinstallation. This warranty is void if this product is installed improperly or in an improper environment, overloaded, misused, opened, abused, or altered in any manner, or is not used under normal operating conditions or not in accordance with any labels or instructions. There are no other or implied warranties of any kind, including merchantability and fitness for a particular purpose, but if any implied warranty is required by the applicable jurisdiction, the duration of any such implied warranty, including merchantability and fitness for a particular purpose, is limited to two years. Leviton is not liable for incidental, indirect, special, or consequential damages, including without limitation, damage to, or loss of use of, any equipment, lost sales or profits or delay or failure to perform this warranty obligation. The remedies provided herein are the exclusive remedies under this warranty, whether based on contract, tort or otherwise.

For Technical Assistance Call:
1-800-824-3005 (U.S.A. Only)
1 800 405-5320 (Canada Only)
www.leviton.com



PK-92955-20-00-0A

5. Restore power at circuit breaker or fuse. Position the dimmer so that the rocker switch is at the bottom. As you move the slider upward, the brightness level increases. The rocker switch below the slider panel is for ON/OFF switching. With the rocker in the ON position and the slider in the minimum brightness position, adjust the trim for the desired level (described in the next step).
6. The trim adjustment is located at the top of the dimmer back cover, just behind the metal finned plate. Using a small insulated screwdriver, turn the trim adjustment until you've reached the desired brightness level.
7. Check for proper operation by setting the slider to its maximum position and returning it to minimum. If operation is not satisfactory, repeat step 5.
8. **TURN OFF POWER.** Installation may now be completed by carefully positioning all wires to provide room in outlet box for dimmer. Mount dimmer into box with mounting screws supplied. Snap plastic cover into place.
9. Restore power at circuit breaker or fuse. **INSTALLATION IS COMPLETE.**

Outlet boxes required for ganging Leviton Renoir™ dimmers when no fins are removed.

TABLE 1 - OUTLET BOX REQUIREMENTS								
Wide Dimmers (1500W)	Narrow Dimmers (800W/1000W)							
	0	1	2	3	4	5	6	7
0	0	1	3	5	6	9	10	
1	1	4	5	7	8	10		
2	4	6	8	9				
3	7	9	10					
4	9							

Outlet boxes required for ganging Leviton Renoir™ dimmers when all inside fins are removed.

TABLE 2 - OUTLET BOX REQUIREMENTS										
Wide Dimmers (1500W)	Narrow Dimmers (800W/1000W)									
	0	1	2	3	4	5	6	7	8	9
0	0	1	2	3	4	5	6	7	8	9
1	1	3	4	5	6	7	8	9	10	
2	3	5	6	7	8	9	10			
3	5	7	8	9	10					
4	7	9	10							
5	9									

TABLE 3 - MAXIMUM LOAD PER DIMMER

Cat. No.	Single	Two Gang	More than 2 Gang
80800	800W	700W	600W
81000	1000W	800W	700W
81500	1500W	1300W	1000W
82000	2000W	1800W	1500W

Figure 2 - Break-Off Fin Removal

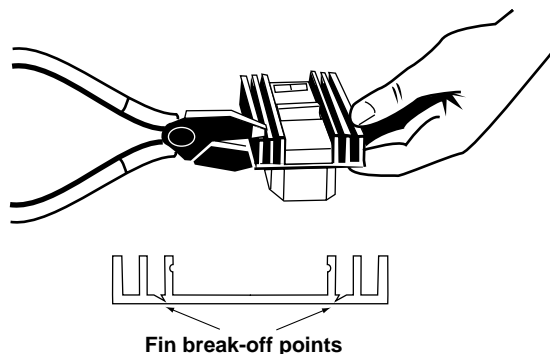

Wiring Diagram 1 - Single Location Control Application

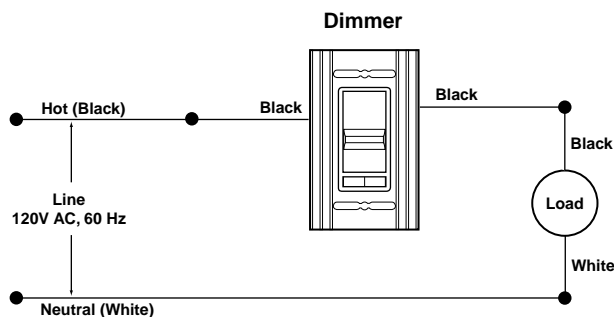

Wiring Diagram 2 - Two Location Control Application

