

WARNINGS AND CAUTIONS:

For Occupancy Sensors installed to control Emergency Lighting Equipment:

If this equipment is being used for Emergency Lighting and Power Equipment, please adhere to the following information. This equipment is rated for only 25C if used on Emergency Lighting Equipment. Apply the "Emergency Circuits" label (provided) to the front cover.

IMPORTANT SAFEGUARDS

When using electrical equipment, basic safety precautions should always be followed, including the following:

a) READ AND FOLLOW ALL SAFETY INSTRUCTIONS.



- DO NOT use outdoors.
- DO NOT mount near gas or electric heaters.
- Equipment should be mounted in locations and at heights where it will not readily be subjected to tampering by unauthorized personnel.
- The use of accessory equipment not recommended by manufacturer may cause an unsafe condition.
- DO NOT use this equipment for other than the intended use.

SAVE THESE INSTRUCTIONS

All servicing shall be performed by qualified service personnel. If any Emergency Circuits are fed or controlled from this panel, it must be located electrically where fed from a UPS, generator, or other guaranteed source of power during emergencies and power outage situations.

Infrared Ceiling Mounted Occupancy Sensor California Title 20 Compliant No Minimum Load Required

INSTALLATION INSTRUCTIONS

Rating: 6A-6AX 250V 				720-1440 W/VA	120-240 50Hz
120 V 60 Hz	8 A, Electronic Ballast	277 V 60 Hz	5 A, Electronic Ballast		
	800 W/VA, Tungsten, Ballast		1200 VA, Ballast		
	1/4 Hp		1/3 Hp		

CATALOG ITEMS					
Cat. No.	Description	Voltage Range	Current Consumption	Coverage	Suggested Mounting Location
O2C04-IDW	High Density	120-277V, 50/60 Hz	60-30 ma	450 sq. ft.	Mount in center of room/area, 8-12 ft height
O2C15-IDW	Extended Range	120-277V, 50/60 Hz	60-30 ma	1500 sq. ft.	Mount in center of room/area, 8-12 ft height

WARNINGS AND CAUTIONS:

- TO AVOID FIRE, SHOCK, OR DEATH: TURN OFF POWER AT CIRCUIT BREAKER OR FUSE AND TEST THAT POWER IS OFF BEFORE WIRING!
- To be installed and/or used in accordance with appropriate electrical codes and regulations.
- If you are unsure about any part of these instructions, consult an electrician.
- Sensors must be mounted on a vibration free surface.
- Do not terminate using data type wire, such as Cat 5/E.
- Do not mount sensors closer than 10 feet to each other.
- All sensors must be mounted at least 6 feet away from air vents, air handlers, and reflective surfaces (windows/mirrors).

NOTES

- Do not touch the surface of the lens. Clean outer surface with a damp cloth only.
- Operating Temperature:** 32° to 104°F (0° to 40°C)
- Compatible with electronic and magnetic ballasts, electronic and magnetic low-voltage transformers, incandescent lamps, and fans.

TOOLS NEEDED TO INSTALL YOUR SENSOR

- Slotted/Phillips Screwdriver
- Wire stripper
- Small Slotted Screwdriver
- Cutters

PARTS INCLUDED LIST

- Sensor (1)
- 4" x 4" Mounting Plate (1)
- #6-32 x 1-1/2" Screw (2)
- Mid-Range Lens [red frame] (1)
- Emergency Label (1)
- Angled Light Pipe (1)
- 360° Perforated Mask (1)
- Low Voltage Connector (1)
- Half Mask (1)
- Tubing Barrier (1)

DESCRIPTION

The Occupancy Sensor is a LINE-voltage infrared sensor to automatically control lighting. The sensor turns the lights ON and keeps them ON whenever occupancy is detected and will turn them OFF after the "delayed-off time" has expired. The sensor continually analyzes and adjusts to changing conditions. The sensor uses the latest microprocessor-based technology which permits it to continually adjust and optimize its performance. Infrared motion detection gives higher false triggering immunity that yields a sensor with excellent performance.

INSTALLING YOUR OCCUPANCY SENSOR

NOTE: Use check boxes when Steps are completed.

Step 1 WARNING: TO AVOID FIRE, SHOCK, OR DEATH; TURN OFF POWER at circuit breaker or fuse and TEST that power is off before wiring!

Step 2 Identifying your wiring:

- Line (Hot) - L1
- Load - L1 →
- Neutral - N
- Load - L2
- Load - L2 →
- Manual Switch +
- Manual Switch -
- Emergency Interface +
- Emergency Interface -

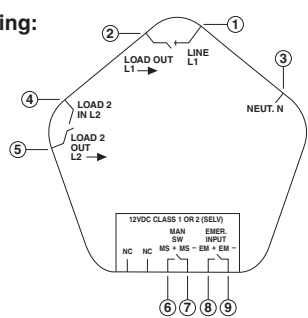

Step 3 Preparing and connecting wires:

- Make sure that the ends of the wires from the electrical box are **straight (cut if necessary)**.
- Remove insulation from each wire in electrical box as shown.
- Wire per Specifications:
 - Line, Neutral, Load Wires (Copper)**
Wire range: #12-18 AWG, 3.3 - 0.75 mm square
Torque rating: 20 lb-in, 23 kgf-cm.
 - Control Wires (Manual Switch and Emergency Interface)**
Wire range: #16-26 AWG, 4.0 - 0.12 mm square
Torque rating: 2.5 lb-in, 2.88 kgf-cm.



Step 4 Installing your sensor:

Connect wires per WIRING DIAGRAM as follows:

- Insert wires into proper terminals. Use a screwdriver to turn terminal screws clockwise and secure wires.
 - Line wire to Line terminal.
 - Neutral wire to Neutral terminal.
 - Load wires to Load terminals. **NOTE:** Both loads **MUST** be fed from the same phase. **NOTE:** When wiring Manual Switch and Emergency Interface to their respective marked terminals. **NOTE:** Wires need to be inserted from the top through the wire holes provided on the sensor and clamped down using the washer to the terminals.

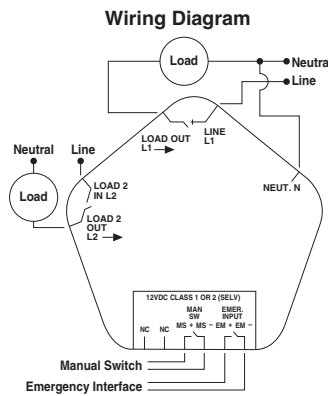

Mount Sensor in Electrical Box

To mount inside 4" octagon 2.125" deep ceiling electrical box, refer to Figure 1.

- Dress line voltage wires to provide enough clearance in electrical box when device is installed.
- Partially thread two #8-32 screws (not included) into the mounting holes of the electrical box.
- Pull out the two coasters that align with the two screws.
- Align sensor so that it fits between the mounting holes of the electrical box and insert over mounting screws.
- Push in the two coasters that align with the two screws.
- Tighten mounting screws firmly.

Figure 1

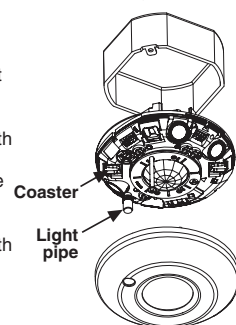

Mount Sensor in Electrical Box with Mud Ring

To mount inside 4" square 1.5" deep ceiling electrical box with mud ring, refer to Figure 2.

- Ensure that conduit/cable entry clamp is located in corner of electrical box.
- Dress line voltage wires to provide enough clearance in electrical box when device is installed.
- Install a two-gang mud ring (not included) on electrical box.
- Partially thread the two #6-32 screws provided into the mounting holes of the electrical box.
- Pull out the two coasters that align with the two screws.
- Align sensor so that it fits between the mounting holes of the electrical box and insert over mounting screws.
- Push in the two coasters that align with the two screws.
- Tighten mounting screws firmly.

Figure 2

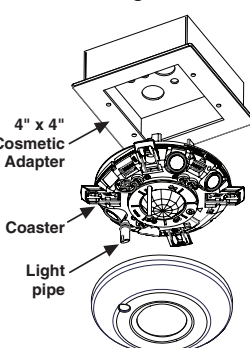

OCCUPANCY SENSOR OPERATION

Motion detection by the infrared sensor will turn the lights ON as well as keep them ON. When motion is not detected, the lights will turn OFF after the delayed-off time.

- Delayed-Off time:** The sensor is designed to turn the lights OFF if no motion is detected after a specified time. This length of time is called the delayed-off time and is set using the timer (Black) knob on the sensor.
- Walk-through Mode:** The walk-through feature is useful when a room is momentarily occupied. The walk-through feature works as follows: When a person enters the room, the lights will turn ON. If the person leaves the room before the default walk-through timeout of 2.5 minutes, the sensor will turn the lights OFF 2.5 minutes later. If the person stays in the room for longer than 2.5 minutes, the sensor will proceed with the standard operation.
- Reset Device State:** To reset Auto adapting and photocell settings to factory default.
- Manual ON/OFF Switch:** Use to override occupancy and manually turn the lights ON or OFF by pressing the low voltage momentary/toggle switch. Pressing manual switch will reset the time delayed OFF timer and lights will turn OFF after the delayed-off timer expires.
- Emergency Interface:** This input is intended for use with BMS (Building Management System) or any contact closure to force the lights ON in case of emergency. Lights will stay ON until emergency signal is cleared.

Modes of Operation: Selectable using Bank C Dip Switches

The Auto ON/Auto OFF Occupancy Sensor can be turned ON and OFF automatically based on occupancy, a timer, panel or BMS input, and manually from an optional low voltage switch.

Mode 1 – Manual ON (No daylighting in this mode)

Occupants must press the Manual Switch to turn both loads ON. Both loads can be manually turned OFF with the Manual Switch. Both loads will automatically be turned OFF when the sensor's time delay expires. If occupancy is detected up to 30 seconds after the time delay expires, both loads turn back ON. Otherwise, both loads remain OFF and the Manual Switch must be used to turn both loads ON.

Mode 2 – Auto ON

Both loads will be automatically turned ON when occupancy is detected (if not held OFF by daylighting control). Both loads can be manually turned ON with the Manual Switch. Both loads will automatically be turned OFF when the sensor's time delay expires.

Mode 3 – Bathroom Control (Daylighting controls load 1 only)

Both loads will be automatically turned ON when occupancy is detected (if load 1 is not held OFF by daylighting control). Both loads can be manually turned ON with the Manual Switch. Load 1 can be manually turned OFF with the Manual Switch. Load 1 will automatically be turned OFF when the sensor's time delay expires. Load 2 will be turned OFF 10 minutes after the sensor's time delay expires or 10 minutes after load 1 is turned OFF.

Mode 4 – Auto ON / Manual ON

Load 1 operates as Auto ON and load 2 as Manual ON. If load 1 is ON and load 2 is OFF, the Manual Switch will turn load 2 ON. If both loads are ON, the Manual Switch will turn both loads OFF. If both loads are OFF, the Manual Switch will turn both loads ON.

Mode 5 – Stairwell Control

Both loads will be automatically turned ON when occupancy is detected (if not held OFF by daylighting control). Both loads can be manually turned ON with the Manual Switch. Load 1 and load 2 alternate between ON and OFF when the sensor's time delay expires, so that one load is always ON. While under daylighting control, if the natural light level is sufficient then both loads will be turned OFF, regardless of occupancy state. The Manual Switch can be used to turn only one load OFF at a time.

Mode 6 – Step Dimming: Alternating (Operates as Mode 2 if photocell is not calibrated)

Both loads will be automatically turned ON when occupancy is detected and there is insufficient natural light. Both loads can be manually turned ON with the Manual Switch. As natural light increases above the daylighting set point, loads 1 and 2 will alternate between ON and OFF (50%). Loads 1 and 2 turn OFF (0%) when natural light is sufficient, regardless of occupancy state. The reverse operation occurs as natural lights decreases. Manual Switch: Controls Relays 1 & 2; when at 0% - lights go to 100%, when at 50% - lights go to 100%, when at 100% - lights go to 0%.

Mode 7 – Step Dimming: Load 1 Primary (Operates as Mode 2 if photocell is not calibrated)

Both loads will be automatically turned ON when occupancy is detected and there is insufficient natural light. Both loads can be manually turned ON with the Manual Switch. As natural light increases above the daylighting set point, load 2 will turn OFF first (50%). Load 1 will turn OFF second (0%) when natural light is sufficient, regardless of occupancy state. The reverse operation occurs as natural light decreases, load 1 will turn ON first (50%). Manual Switch: Controls Relays 1 & 2; when at 0% - lights go to 100%, when at 50% - lights go to 100%, when at 100% - lights go to 0%.

Presentation Mode: Applies on all modes - If both loads are switched OFF with the Manual Switch, the occupancy sensor will not turn the load(s) ON automatically until after the sensor's time delay expires.

Modes of Operation: Selectable using Bank B Dip Switches

Forced Mode: Both Loads will be overridden to a Forced ON or Forced OFF State. Refer to Table 2 for switch settings.

- Ensure power is ON.
- Remove front cover.
- Locate dip switch 1 in Bank B. B1 will be in the OFF position (Normal Mode) from the factory.
- To enable Forced Mode, move the switch to ON.

Forced State: Override ON/Override OFF, Refer to Table 2 for switch settings.

- Enable Forced Mode.
- Locate dip switch 2 in Bank B. B2 will be in the OFF position from the factory.
- To select the OFF state, move the switch to OFF. To select the ON state, move the switch to ON.

Test Mode: To set the delayed-off time to 4 seconds for performing a walk test. While the sensor is in test mode, the LED will flash YELLOW once every second. Refer to Table 2 for switch settings.

- Ensure power is ON.
- Remove front cover.
- Locate dip switch 3 in Bank B. B3 will be in the OFF position from the factory.
- To enter Test mode, move switch to ON. If B3 is already in the ON position, then Test mode can be entered by just moving it to the OFF and then ON position. The timer will remain in the 4 second Test mode for 15 minutes, then automatically exit Test mode and reset to the delayed-off time setting as defined by the Black timer knob. To manually take the timer out of the 4 second Test mode, simply move switch B3 back to OFF. **NOTE:** Entering Test mode will reset all adapted settings.

LEDs State: LEDs are enabled from the factory, to disable the LEDs move the B4 dip switch to ON.

Reset Device State: If a sensor is moved to a new location it should be reset before entering Test Mode.

AUTO ADAPTING

The Sensor continually analyzes the parameters of the motion detection signal and adjusts its internal operation to maximize detection of motion while minimizing the effects of noise (electrical noise, air currents, temperature changes, etc...).

Operation

When the sensor is first installed, the delayed-off time for the occupied mode is based on the Time adjustment settings. While the sensor is in use, the delayed-off time will change, based on how the sensor adapts to the room conditions. The adapted settings can be reset by moving B3 from OFF to ON to OFF position.

Occupancy Pattern Learning For Delayed-Off Time

The sensor will automatically change the Delayed-Off Time in response to detected occupancy patterns. The Delayed-Off Time will be decreased if large periods of vacancy are detected, which will result in energy savings. The Delayed-Off Time will be increased if false-off conditions are detected.

Occupancy Pattern Learning for Infrared Technology

The sensor learns the occupancy patterns of a space during the course of a day, for a seven day period. The sensor will adjust the sensitivity to make it less likely to turn ON during a historically vacant time period.

PHOTOCELL AND DAYLIGHTING OPERATIONS

Daylight harvesting is used for additional energy savings. The photocell holds the lights OFF when sufficient ambient light is present. Typical light levels are measured in foot-candles or lux, and average office areas are designed to utilize 50-60 foot candles/500-600 lux. The "Daylight Design Level" (DDL), when set per the calibration section, will be the set point which engages the hold-off feature for daylight harvesting.

CALIBRATION

After the sensor is installed, the photocell must be configured correctly to maintain the desired light level and gain additional energy savings. To achieve this, the installer first needs to understand Closed and Open Loop Daylighting, then decide which application best fits the customer's needs before configuring and calibrating the device.

- Open Loop:** When a photocell (light pipe) is focused on an area which is primarily illuminated by natural light from windows or skylights, along with a minimal amount of artificial light from the lights it is controlling. **NOTE:** Use the **angled light pipe** for Open Loop applications. Open Loop **MUST** be used only with Manual Calibration mode. The sensor will not enter Automatic Calibration mode if Open Loop Daylight Harvesting is selected.
- Closed Loop:** When a photocell (light pipe) is focused on an area which is primarily illuminated by the lights it is controlling. **NOTE:** Use the **flat light pipe** for Closed Loop applications.

Please allow a 30 second warm up period after applying power. For best calibration results, personnel should maintain at least a 6 foot distance from the device 2 minutes after the start of Auto and Manual Calibration. **NOTE:** to disable photocell or cancel calibration turn knob to SET/OFF for longer than 5 seconds (RED LED followed by YELLOW flash). When changing photocell modes or recalibrating, disable photocell and follow directions below:

Manual Mode: Available for both Open and Closed Loop applications to quickly configure the Daylight Design Level (DDL). Calibration should always be done when ambient light is at user's desired level.

Procedure - Open Loop/Closed Loop

- Move dip switch C4 to ON (for Open Loop), or to OFF (for Closed Loop).
- Install appropriate light pipe.
 - Open Loop:** Install angled light pipe with the longest side facing toward the natural light source (window) - see Figure 3A.
 - Closed Loop:** Install the flat light pipe (factory installed).
- Turn the photocell knob (fully counterclockwise) to SET/OFF for 2 seconds (LED will be solid RED indicating the device has entered Manual Calibration mode). Then turn the knob to SETPOINT (1X) - see Figure 4.
- Re-install sensor cover.
- Lights are forced ON for 3 minutes, then OFF for 1 minute (Open Loop only).
- LED blinks RED (3 minutes). **Optional** - During this time, the DDL can be adjusted by turning the knob up or down. **NOTE:** The LED blinks BLUE when the knob setting has changed.
- When Manual Calibration is complete, the LED will resume normal operation. The device is now operating in Manual mode.

Auto Mode: Auto mode is available ONLY for Closed Loop applications to configure the DDL in 24 hours. The sensor will not enter Auto Calibration mode if Open Loop Daylight Harvesting is selected.

Procedure

- Move dip switch C4 to OFF position.
- Install the flat light pipe (factory installed).
- Turn the photocell knob (fully clockwise) to AUTO (LED will be solid GREEN for 24 hours indicating the device has entered Auto Calibration mode).
- Re-install sensor cover.
- When Auto Calibration is complete, the LED will resume normal operation. The device is now operating in Auto mode.

PHOTOCELL OPERATION

- In order to keep the lights from needlessly cycling ON and OFF, the OFF trigger point is set at a higher light level than the ON trigger point. In addition, there is a delay time that must be met which requires the light level to be above or below the trigger point for a period of time before a light change occurs. For example, there may be a 10% hysteresis gap between the OFF and ON trigger points, along with a 5 minute delay time to turn OFF the lights and a 1 minute time delay to turn ON the lights.
- OFF and ON trigger point levels can be adjusted at any time using the Photocell knob. **NOTE:** In order to make quick adjustments to DDL, the delay time for lights ON/OFF will be reduced from 1 min/ON and 5 min/OFF, to 30sec/ON or OFF once Photocell knob change is recognized. The reduced delay time will expire 2 minutes after knob change occurs. **NOTE:** The LED blinks BLUE when the knob setting has changed.
- To disable photocell or cancel calibrations turn the knob to SET/OFF (RED LED, YELLOW flash). Every 30 seconds, the LED turns ON BLUE for 2 seconds when the photocell is holding the lights OFF.

Open Loop

- In Open Loop application the longer side of the angled light pipe must be facing toward the natural light source (window). See Figure 3A.
- The graph in Figure 3A tracks the value of a linear photocell throughout a day. It is assumed that it is a cloudless day so the increase of the daylight is relatively linear. The far left of the graph starts out at night and shows a very low level reading. At dawn, the level begins to increase. At some point, based on the setting of the trigger point, the lights will be turned OFF since there is enough contribution from the daylight. The photocell reading will begin to decrease around noon until the level matches the trigger point, then lights will be turned back ON.

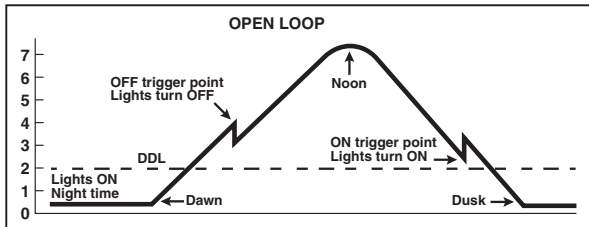
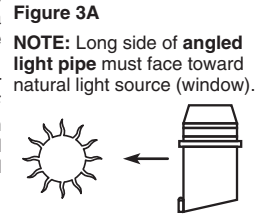

Closed Loop

- The graph in Figure 3B tracks the value of a linear photocell throughout a day. It is assumed that it is a cloudless day and that the desired light level is the same level without external light influence and only by the fixture(s). At the far left, the lights are ON because the area is occupied and since it is still night, there is no contribution from daylighting. As dawn arrives, the photocell level begins to increase as the daylight increases. In order to keep the light level from dropping below the trigger point, and in this case below the desired light level in the area (DDL), the trigger point is set to 2.5 times the level read with only the fixture(s). That way, the light is still adequate to hold the lights OFF. This is shown in the graph at the point where the level suddenly drops. The photocell level then continues to increase until around noon. As the daylight decreases, the area light eventually drops to near the desired light level. Before reaching this point, the lights are turned back ON, indicated by the sudden increase in the photocell level.

Figure 3B
Flat light pipe

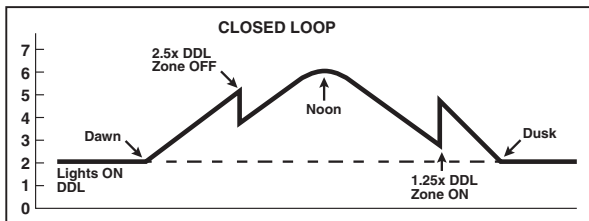

LED INDICATORS

- RED** - Blinks upon PIR detection. Can be disabled by moving B4 to ON (See Table 2). Solid for 3 minutes then blinks for 3 minutes during photocell manual calibration. Solid when device malfunctions.
- GREEN** - Solid for 24 hours during photocell auto calibration.
- YELLOW** - Blinks in test mode. Solid with emergency interface/BMS input on.
- BLUE** - Blinks when the knob setting has changed. Solid ON for 2 seconds every 30 seconds when the photocell is holding the lights OFF.

SETTINGS

Default Settings:

Adjust knob settings as per "recommended manual settings," (refer to Figure 4 and Table 1).

All switches in the OFF position, except A3, A4, C1, C2, C3 are set to ON (refer to Table 2).

Figure 4 - Knob Settings

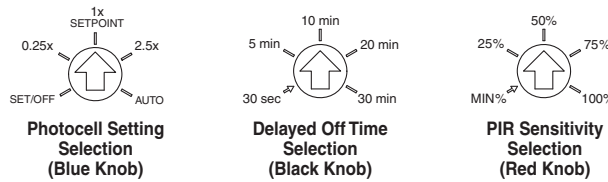

TABLE 1: ADJUSTMENT KNOB SETTINGS				
Knob Color	Symbol	Function	Knob Setting	Factory Default Setting
Red		Sets Infrared Range	Range Setting Full CCW = min. (OFF) Full CW = max.	75%
Black		Delayed - OFF Time	Full CCW = min. (30 sec) Full CW = max. (30 min)	50% (10 min)
Blue		Ambient Light Override (Photocell)	Full CCW - SET/OFF (NO ambient light override) Full CW - Auto Calibration Range - 3-16000 Lux	0%

TABLE 2: SWITCH SETTINGS			
SWITCH	SWITCH FUNCTIONS	SWITCH SETTINGS	
	Bank A	OFF	ON
A3	Manual Mode	Auto Adapting Enabled	Auto Adapting Disabled
A4	Walk-Through	Walk-Through Enabled	Walk-Through Disabled
	Bank B	OFF	ON
B1	Forced Mode	Normal	Override Enabled (B2)
B2	Forced State	Override OFF	Override ON
B3	Test Mode	Disabled	Enabled OFF → ON
B4	LEDs State	LEDs Enabled	LEDs Disabled
B5	Reset Device State	OFF → ON → OFF	

DUAL RELAY MODES OF OPERATION				
Oper. Mode	Bank C			Behavior
	C1	C2	C3	
Mode 1	OFF	OFF	OFF	Load 1: Manual ON/Auto OFF Load 2: Manual ON/Auto OFF
Mode 2	ON	ON	ON	Load 1: Auto ON/Auto OFF Load 2: Auto ON/Auto OFF
Mode 3	ON	OFF	OFF	Load 1: Auto ON/Auto OFF Load 2: 10 minute delay OFF
Mode 4	OFF	ON	OFF	Load 1: Auto ON/Auto OFF Load 2: Manual ON/Auto OFF
Mode 5	ON	ON	OFF	Load 1: Alternate ON/Auto OFF Load 2: Alternate ON/Auto OFF
Mode 6	OFF	OFF	ON	Load 1: Step Dimming - Alt. Load 2: Step Dimming - Alt.
Mode 7	ON	OFF	ON	Load 1: Step Dimming - ON Load 2: Step Dimming - ON/OFF
C4	Daylight Harvesting - OFF Closed Loop / ON Open Loop			

Figure 5 - (Cat. No. O2C04) Field-of-View Ranges
High density lens (blue frame), mounting height (8-12 ft)

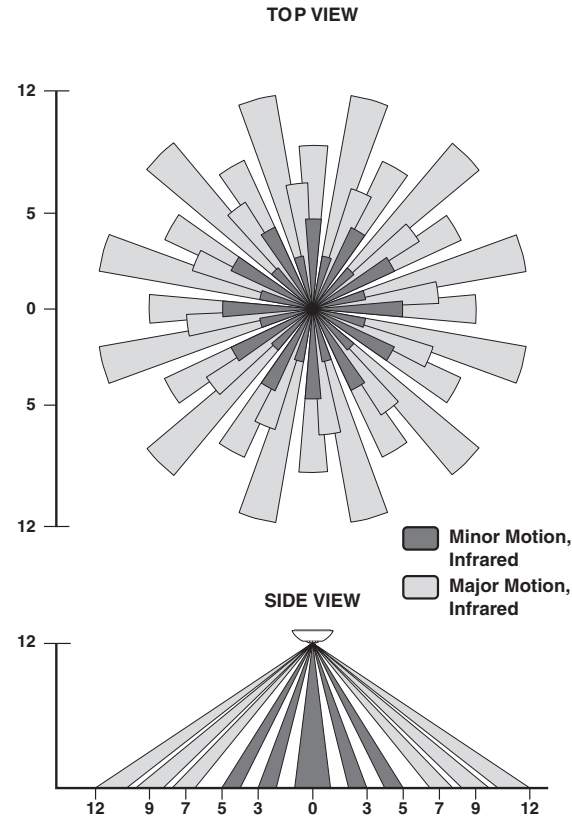

Figure 6 - (Cat. No. O2C15) Field-of-View Ranges
Extended range lens (black frame), mounting height (8-12 ft)

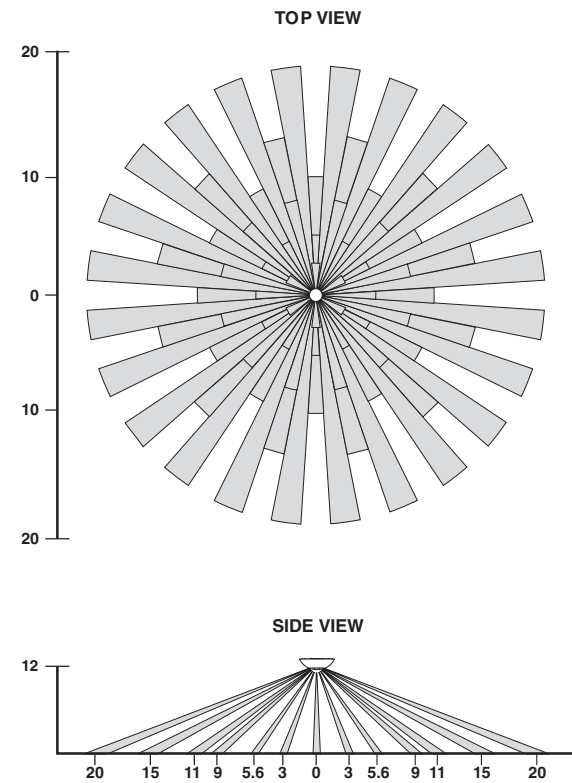

Figure 7 - (Mid-Range Lens) Field-of-View Ranges
Mid range lens (red frame), mounting height (13-20 ft)

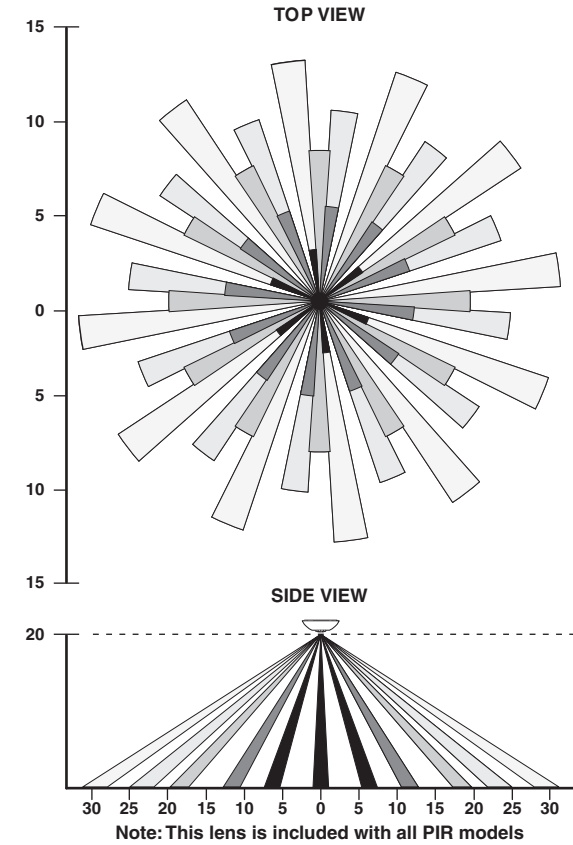

Figure 8 - Changing PIR Lens
To change lens, turn lens and line up arrows, then pull lens from sensor

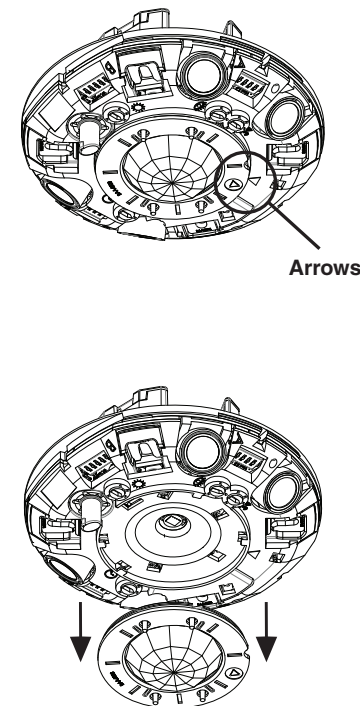
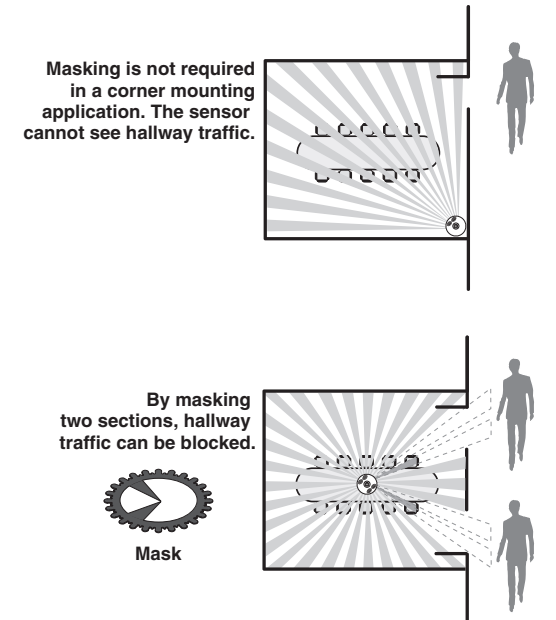

Figure 9 - Mounting Location Diagram



TROUBLESHOOTING

- Lights do not turn ON**
 - Circuit breaker or fuse has tripped.
 - Forced Mode is enabled with the Forced State set to OFF. To disable the Forced Mode refer to Table 2 for switch settings.
- Lights stay ON**
 - Constant motion. **To Test:** Reduce RED knob by 25%; remove motion source. If unsatisfactory, move sensor.
 - Infrared sensor can "see" into hallway. **To Test:** Put sensor in Timer Test mode and walk hallway. If lights continue to come ON, move sensor.
 - Forced Mode is enabled with the Forced State set to ON. To disable the Forced Mode refer to Table 2 for switch settings.
- Light turns ON too long**
 - Timer setting too high. **To Test:** Check switch settings. Typical setting is 10 minutes.
 - LED illuminates solid RED for longer than 5 minutes, device malfunction, contact technical assistance.

PRODUCT INFORMATION

- For technical assistance, contact us at **1-800-824-3005**
- Visit our website at www.leviton.com

FCC COMPLIANCE STATEMENT

This device complies with part 15 of the FCC rules. Operation is subject to the following two conditions: (1) This device must not cause harmful interference, and (2) This device must accept any interference received, including interference that may cause undesired operation. Any changes or modifications not expressly approved by Leviton could void the user's authority to operate this equipment.

PATENTS

This product may be covered by US PAT. Nos. 8,154,154; 7,924,155; 8,227,731; 7,608,807 and 8,115,626.

FOR CANADA ONLY

For warranty information and/or product returns, residents of Canada should contact Leviton in writing at **Leviton Manufacturing of Canada Ltd to the attention of the Quality Assurance Department, 165 Hymus Blvd, Pointe-Claire (Quebec), Canada H9R 1E9** or by telephone at **1 800 405-5320**.

© 2017 Leviton Mfg. Co., Inc.

PK-93871-10-00-2D

LIMITED 5 YEAR WARRANTY AND EXCLUSIONS

Leviton warrants to the original consumer purchaser and not for the benefit of anyone else that this product at the time of its sale by Leviton is free of defects in materials and workmanship under normal and proper use for five years from the purchase date. Leviton's only obligation is to correct such defects by repair or replacement, at its option. **For details visit www.leviton.com or call 1-800-824-3005.** This warranty excludes and there is disclaimed liability for labor for removal of this product or reinstallation. This warranty is void if this product is installed improperly or in an improper environment, overloaded, misused, opened, abused, or altered in any manner, or is not used under normal operating conditions or not in accordance with any labels or instructions. **There are no other or implied warranties of any kind, including merchantability and fitness for a particular purpose,** but if any implied warranty is required by the applicable jurisdiction, the duration of any such implied warranty, including merchantability and fitness for a particular purpose, is limited to five years. **Leviton is not liable for incidental, indirect, special, or consequential damages, including without limitation, damage to, or loss of use of, any equipment, lost sales or profits or delay or failure to perform this warranty obligation.** The remedies provided herein are the exclusive remedies under this warranty, whether based on contract, tort or otherwise.