

# Occupancy Sensor Power Base

Cat. No. OPB15

Rated: 120-277 VAC, 50/60 Hz

Incandescent: 15 A @ 120 VAC, Fluorescent: 15 A @ 120 VAC - Ballast, 15 A @ 277 VAC - Ballast, 3/4 Hp @ 120 VAC

Operating Temperature: 0°C to 40°C (32°F to 104°F) - Relative Humidity: 0% to 90% non-condensing.

For use with OSCxx Occupancy Sensors



DI-000-OPB15-00B

## INSTALLATION INSTRUCTIONS

### WARNINGS AND CAUTIONS:

- **TO AVOID FIRE, SHOCK, OR DEATH: TURN OFF POWER AT CIRCUIT BREAKER OR FUSE AND TEST THAT POWER IS OFF BEFORE WIRING!**
- To be installed and/or used in accordance with appropriate electrical codes and regulations.
- If you are unsure about any part of these instructions, consult an electrician.

CATALOG ITEMS		
Catalog No.	Power Input	Power Output
OPB15-0DW	120-277VAC, 50/60Hz	24VDC, 40mA

- Input voltage tolerance 10%
- Output voltage tolerance 15%, Output voltage listed at nominal.

### WARNINGS AND CAUTIONS:

- Sensors must be mounted on a vibration free surface.
- All sensors must be mounted at least 6 feet away from air vents, air handlers, and reflective surfaces (windows/mirrors).
- Disconnect power when servicing fixture or changing lamps.
- Use this device with **copper or copper clad wire only**.

### Tools needed to install your Sensor

- Slotted/Phillips Screwdriver
- Pliers
- Cutters

### Parts Included List

- Sensor Base (1)
- #8-32 x 3/4" Screw (2)
- #6-32 x 13/16" Screw (2)

### FEATURES

- Adapts OSCxx Sensors to line-voltage
- 24VDC Output
- Mounts inside a 2.125" deep octagon or 4" square Electrical Box (w/mud ring).

### DESCRIPTION

The OPB15 adapts Leviton low-voltage ceiling occupancy sensors to operate on line-voltage electrical systems. Designed to control up to 15 amps of lighting load from a single occupancy sensor. The Power Base contains a power supply and a load switching relay. The power supply provides Class 2 low-voltage power for OSCxx Series Occupancy Sensors. The relay in the Power Base is controlled by the occupancy sensors connected via the control input of the two-part terminal connector. The Power Base includes zero cross switching circuitry to minimize inrush current associated with electronic ballasts. This reduces wear and tear on the relay contacts making the power pack last longer.

### Application Notes:

OPB15 works well where installation of a low-voltage wiring typical with traditional power packs and sensors is difficult, inconvenient or costly. It is ideal for existing buildings where access to wiring is limited or for new construction with line-voltage circuiting only.

### LOW-VOLTAGE CURRENT CAPACITY

OPB15 is designed for a single occupancy sensor with a maximum current capacity of 40mA.

### INSTALLING YOUR POWER BASE

**NOTE:** Use check boxes  when Steps are completed.

**Step 1** **WARNING: TO AVOID FIRE, SHOCK, OR DEATH; TURN OFF** power at circuit breaker or fuse and test that power is off before wiring!

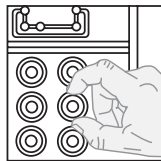
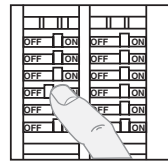

### WIRING DIAGRAM

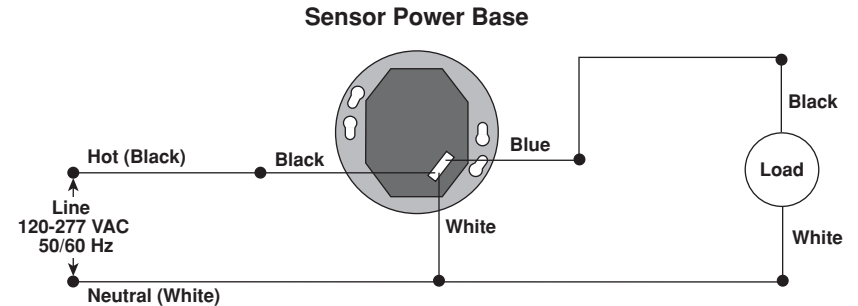

**Step 2** **Preparing and connecting wires:**



Make sure the wires from the wall box are straight (cut if necessary). Remove insulation from each wall box wire and Sensor Power Base as shown:

### Strip Gage

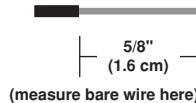
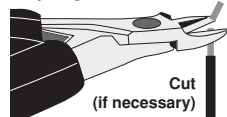

**Step 3** **Wiring your Sensor Power Base (Line Voltage):**



**NOTE:** This application is based on the wall box being pre-installed.

Connect wires per **WIRING DIAGRAM** as follows:

- Twist strands of each lead tightly together and, with circuit conductors, push firmly into appropriate wire connector. Screw connectors on clockwise making sure no bare conductors show below the wire connectors.

WIRE DESIGNATIONS		
Signal Name	Color	Gauge
<b>Line Voltage Wires</b>		
Line 120-277V	Black	14 AWG
Neutral	White	14 AWG
Load	Blue	14 AWG
<b>Class 2 Two-Part Terminal</b>		
Common	Black	22 AWG
Power (+24VDC)	Red	22 AWG
Control (Occupancy Sensor)	Blue or Gray	22 AWG

All wires rated at 105° C. 600V insulation. Class 2 wires are Teflon coated.

**Step 4** **Mount power base in desired electrical box application:**



**A. To mount inside 4" octagon 2.125" deep ceiling electrical box, refer to Figure 1. Wire per Step 2.**

- Dress line voltage wires to provide enough clearance in electrical box when device is installed.
- Partially thread the two #8-32 screws provided into mounting holes of the electrical box.
- Align the power base body so that it fits between the mounting holes of the electrical box and insert over mounting screws.
- Turn counter clockwise until it reaches the stops.
- Tighten mounting screws firmly.

Figure 1

Ceiling Installation in a 4" Octagon 2.125" Electrical Box

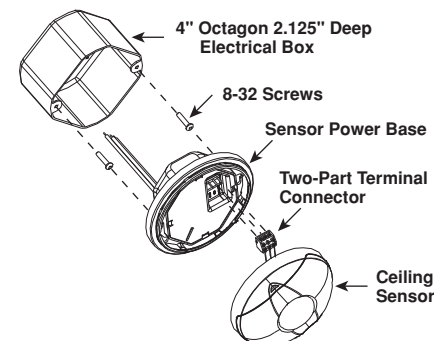

**Step 4 cont'd** **Mount power base in desired electrical box application:**



**B. To mount inside 2.25"x 4"x 4" electrical box with mud-ring, refer to Figure 2. Wire per Step 2.**

- Ensure that conduit/cable entry clamp is located in corner of electrical box.
- Dress line voltage wires to provide enough clearance in electrical box when device is installed.
- Install a two-gang mud ring (not included) on electrical box.
- Partially thread the two #6-32 screws provided into the two-gang mud ring, one on the upper left and one on the lower right, refer to Figure 2.
- Align the Power Base body so that it fits between the mounting holes of the electrical box and insert over mounting screws.
- Turn counter clockwise until it reaches the stops.
- Tighten mounting screws firmly.

**Step 4 cont'd** Mount power base in desired electrical box application:

**Figure 2**  
Ceiling Installation in a 2.125"x 4"x 4" Electrical Box

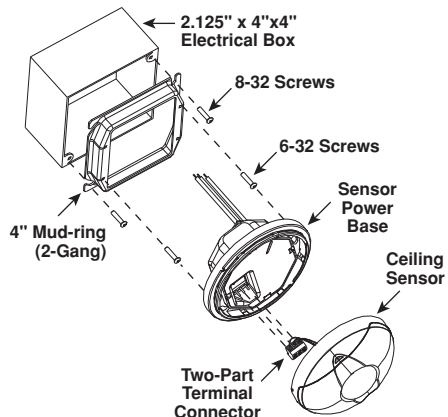

**NOTE:** For existing 1.50" deep electrical boxes, an extension ring in the same shape and size can be added to allow Sensor Power Base to fit.

**Step 5** Mount Ceiling Sensor to Power Base:



**Ceiling Mounted Sensors:**

**NOTE:** Refer to sensor installation sheet.

- Remove ceiling mount sensor mounting base by aligning arrows and pulling apart. Refer to sensor Installation Instructions for full details.
- Remove two-part terminal connector from Sensor Power Base and wire per sensor Installation Instructions. Refer to **Figure 1 and 2**.

**NOTE:** Low-voltage wires should be trimmed approximately in half so the length can fit in mounting cavity between sensor and Power Base and no bare wire is exposed at the connectors.

- Plug the two-part terminal connector into the Power Base with the screws facing up.
- Align mounting indicator arrows on the Power Base and the sensor body and push on to Power Base and turn clockwise a quarter turn to secure.

**Step 6** Sensor Setup:



Refer to sensor Installation Instruction sheet for complete details.

**Step 7** Restore Power:



Restore power at circuit breaker or fuse.  
INSTALLATION IS COMPLETE.

**Operation**

**Close Relay:** When the attached occupancy sensor detects motion, it will apply +24V to the Occupancy wire causing the relay to close.

**Troubleshooting**

- **Lights Flickering**
  - Lamp has a bad connection.
  - Wires not secured firmly with wire connectors.
- **Lights do not turn ON**
  - Circuit breaker or fuse has tripped.
  - Lamp is burned out.
  - Lamp Neutral connection is not wired.
  - Low-voltage mis-wired. Verify wiring connections per appropriate Wiring Diagrams.
  - Line voltage mis-wired. Verify wiring connections per appropriate Wiring Diagrams.
- **Light turns ON**
  - Constant motion. To Test: Adjust sensor; remove motion source. If unsatisfactory, move sensor.
- **Light turns ON too long**
  - Adjust sensor.

**NOTES**

**FCC Compliance Statement**

This equipment has been tested and found to comply with the limits for a Class A digital device, pursuant to part 15 of the FCC Rules. These limits are designed to provide reasonable protection against harmful interference when the equipment is operated in a commercial environment. This equipment generates, uses, and can radiate radio frequency energy and, if not installed and used in accordance with the instruction manual, may cause harmful interference to radio communications. Operation of this equipment in a residential area is likely to cause harmful interference in which case the user will be required to correct the interference at his own expense.

**FOR CANADA ONLY**

For warranty information and/or product returns, residents of Canada should contact Leviton in writing at **Leviton Manufacturing of Canada Ltd to the attention of the Quality Assurance Department, 165 Hymus Blvd, Pointe-Claire (Quebec), Canada H9R 1E9** or by telephone at **1 800 405-5320**.

**LIMITED 5 YEAR WARRANTY AND EXCLUSIONS**

Leviton warrants to the original consumer purchaser and not for the benefit of anyone else that this product at the time of its sale by Leviton is free of defects in materials and workmanship under normal and proper use for five years from the purchase date. Leviton's only obligation is to correct such defects by repair or replacement, at its option. **For details visit [www.leviton.com](http://www.leviton.com) or call 1-800-824-3005.** This warranty excludes and there is disclaimed liability for labor for removal of this product or reinstallation. This warranty is void if this product is installed improperly or in an improper environment, overloaded, misused, opened, abused, or altered in any manner, or is not used under normal operating conditions or not in accordance with any labels or instructions. **There are no other or implied warranties of any kind, including merchantability and fitness for a particular purpose,** but if any implied warranty is required by the applicable jurisdiction, the duration of any such implied warranty, including merchantability and fitness for a particular purpose, is limited to five years. **Leviton is not liable for incidental, indirect, special, or consequential damages, including without limitation, damage to, or loss of use of, any equipment, lost sales or profits or delay or failure to perform this warranty obligation.** The remedies provided herein are the exclusive remedies under this warranty, whether based on contract, tort or otherwise.