

GreenMAX[®] DRC Design Guide



Designing a GreenMAX DRC System

How to Put It All Together

Simple Application Rules

- One Room Controller per room
- 100 network devices per Wired Room Controller; 60 network devices per Wireless Room Controller
- Network rooms together via Wi-Fi

1 Identify your Room Requirements

- Sequence of Operation
- Wired or Wireless System
- Sensor Requirements
- User Interface Requirement
- Load Schedule

2 Select the appropriate ROOM CONTROLLER

- For wired applications:
 - If you have any 0-10V control or switching zones, use the Wired Line Voltage Room Controller (DRC00-Ex0)
 - If all of your loads are Phase Cut, DALI, or DMX, use the Wired Low Voltage Room Controller (DRC00-0L0) and a network power supply (DRC00-0D0)
- For wireless applications:
 - Use the Wireless Keypad Room Controller (DRKDN-Uxx)

3 Select your LOAD CONTROL DEVICE(S) as needed

- Each load type—0-10V, switching, forward phase control, reverse phase control, DMX, DALI, and your preference of wired vs. wireless, will guide you in your selection — see tables on pages 4-5

4 Add SENSORS as needed

- For wired applications:
 - For spaces <500sqft where occupancy/vacancy sensing and daylight harvesting is required, add a Digital Sensor (OSR05-ICW)
 - To use any Leviton Low Voltage Sensor, add the Analog Interface and the desired sensor (Leviton.com/sensors)
 - Ideal for larger spaces or those that require multi-tech sensors
 - Analog Interface (DRID0-C02) required; accommodates two separate sensor zones
- For wireless applications—see table on page 5

5 Select your USER INTERFACE(S)

- Use one or more of the following:
 - 1, 2, 4 or 8-Button Keypads with custom engraving available (DRKDN-CxW)
 - GreenMAC DRC Touch Screen with customizable buttons (TS004-00x)
 - Sapphire Touch Screen with customizable buttons and sliders (TS007-000)
 - GreenMAX DRC App

6 For a NETWORKED SYSTEM, connect rooms with Wi-Fi access points (commonly provided by others, but can be provided by Leviton)

LOW VOLTAGE CURRENT DRAW	
Low Voltage Room Controller (DRC00-0L0)	435-210mA,+12-24Vdc
Digital Switch (DRKDN)	50-25mA,+12-24Vdc
Digital Sensor (OSR05-ICW)	70-35mA,+12-24Vdc
2-Port AI (DRID0)	35mA + connected device consumption,+12-24Vdc
LumaCAN to DALI Gateway (DRCDD)	60mA,+12-24Vdc
Phase Control Dimmer (DRDDP-A40)	100mA

POWER SUPPLIES	
GreenMAX DRC Power Supply (DRC00-0D0)	500mA
LumaCAN Power Supply (PST24-R41)	v3 * 1500mA on RJ45 4100mA Max
<ul style="list-style-type: none"> • Full capacity available on terminals • Commonly used with 6-Port Repeater (NPRPT-6) 	
DIN Rail Power Supply (PST24-I10)	1000mA



Designing a GreenMAX DRC System



Wired

Room Controllers

- The “brain” of the GreenMAX DRC Room Control system
- Manages all the energy management functions in the space

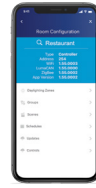

GreenMAX DRC App

Line Voltage Room Controllers

Low Voltage Room Controller

Download at the Apple App Store or Google Play

DRC07-ED0 / DRC07-E30

DRC00-0L0

Load Controls

- Integrate lighting fixtures into the GreenMAX DRC Room Control system
- Incorporates various lighting loads seamlessly into the same GreenMAX DRC Room Control System

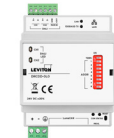
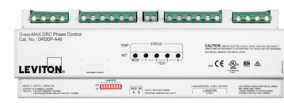

Smart Pack

Phase Control Dimmers

DALI Gateway

Multi-Channel Relay

LumaCAN Gateway

DRD07-ED0 / DRD07-E30

DRDDP-A20 / DRDDP-A40

DRCDD-0L0

DRDD7 / DRDDS

NP00G-000

Sensors

- Gather information from the space and send consistent feedback to the GreenMAX DRC Room Controller
- Allow for daylighting, occupancy/vacancy sensing, etc.



Digital Sensor

Analog Sensors

Analog Interface (AI)
(for use with Analog Sensors)

OSR05/OSR15

Visit Leviton.com/sensors

DRID0-A20/DRID0-A40

User Interfaces

- Allow users to access system features either manually from within the room or remotely
- Recall scenes, zones, dimming/switching levels, and other previously configured information



Digital Keypads*

Touch Screen

Sapphire™ Touch Screen

DRKDN-Cxx

TS007-00x

TS007-000

* Antimicrobial Keypads and Wallplates available. Contact factory for additional information.

Wireless

Keypad Room Controllers

- The “brain” of a GreenMAX DRC Wireless Room Control System when used with Wireless devices
- Manages all the energy management functions in the space with no extra wires



GreenMAX DRC App

Wireless Keypad Room Controllers*

Download at the Apple App Store or Google Play

DRKDN-Uxx

* Antimicrobial Keypad Room Controllers and Wallplates available. Contact factory for additional information.

Load Control Devices

- Expand GreenMAX DRC capabilities with wireless devices. Add wireless control to any ON/OFF, 0-10V dimming or phase cut dimming device



20A ON/OFF Switching Power Pack

10A 0-10V Dimming Power Pack

800W Phase Cut Dimming Power Pack

10A ON/OFF Decora® Wall Switch

0-10V Decora® Wall Dimmer, 120-277V

10A 0-10V Decora® Wall Dimmer, 347V

24V 0-10V Decora® Wall Dimmer

Multi-Way Remote

Zigbee Controlled Receptacle

LU20S-DNW

LU107-DNW

LU04P-1NW

ZS10S-D0Z

ZS057-D0Z

ZS057-30Z

ZS057-ALZ

DLDNK-xxx

ZBR20-1SW

Intellect-Enabled Fixtures by Leviton Lighting Brands and Other Manufacturers*

- Virtually any fixture can be Intellect-enabled with wireless occupancy/vacancy sensing and dimming control

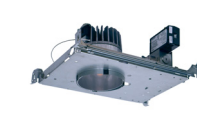

VISCOR

ConTech Lighting

Birchwood Lighting

Intense Lighting

ALRM/ALRA/ALRB

LRTG

LRTH

LCOMN SQ

R4NCIE

R4SQNCIE

R6NCIE

JAKE-LED

SS4G4DR

* Contact factory for additional information.

Sensor

- Gather information from the space and send consistent feedback to the GreenMAX DRC Keypad Room Controller
- Allow for daylighting, occupancy/vacancy sensing, etc.



Zigbee PIR Occupancy Sensor

ZC015-BIW

GreenMAX DRC Wired for 2-Zone Plus Daylighting, Typical

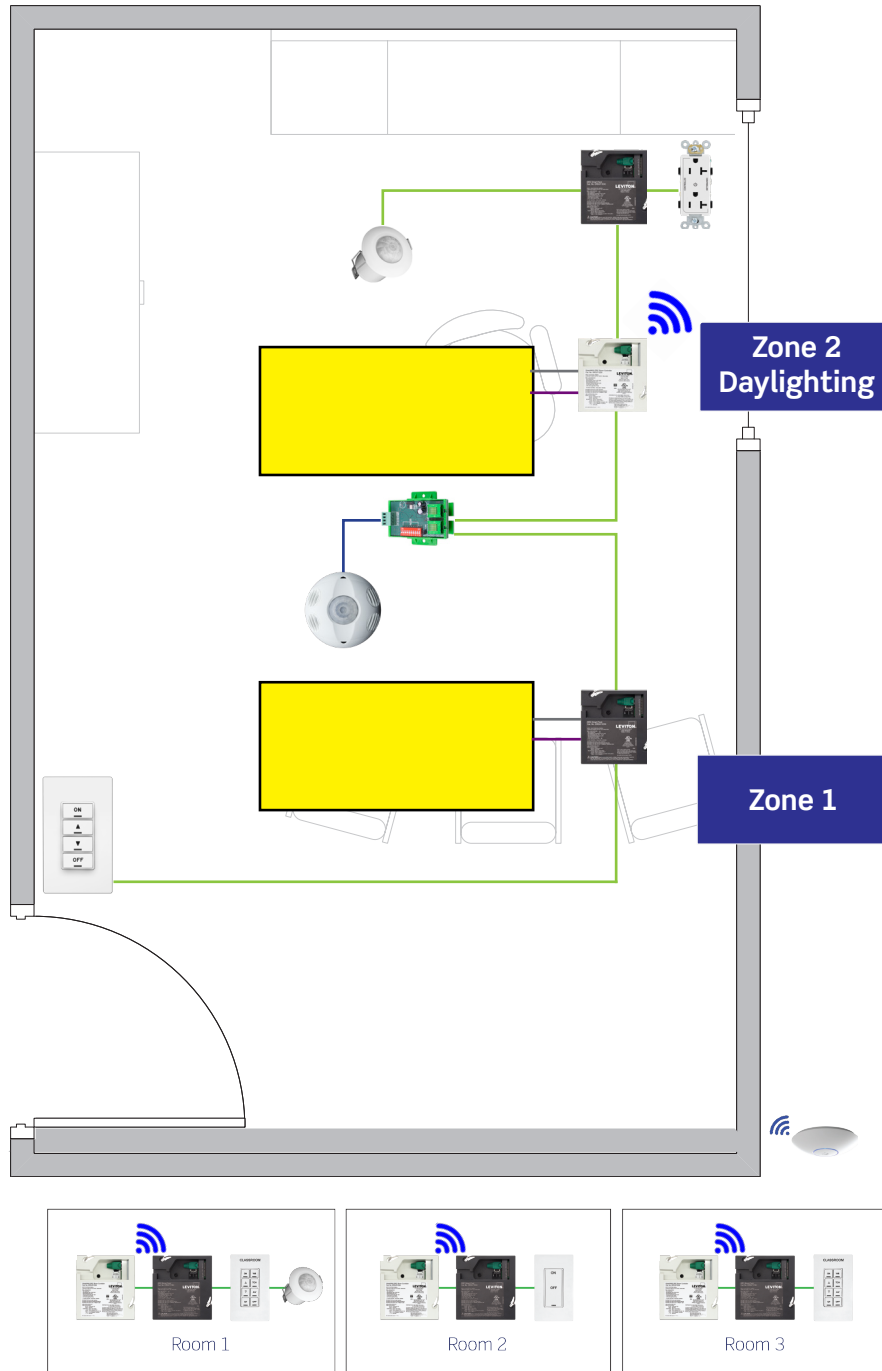

Application Notes

- Room contains two separate zones of lighting, all configured through the GreenMAX DRC App.
- Room has outward-facing windows.
- Individual zones respond to ambient light within the space.
- Occupant can access scenes and dimming/switching controls via their smart device, or by utilizing the manual Keypad control.
- Emergency lighting capable.

Sequence of Operation

- All zone 1 and zone 2 lighting auto-on to 50% and controlled receptacles on when occupancy is detected.
- Local control and bi-level control of general lighting from keypad.
- Daylight zone 1 to dim based on photocell input when there is 150W or greater of lighting in the zone and sufficient daylight is available.
- All lighting and controlled receptacles to turn off automatically when the space is unoccupied after 20 minutes.
- Any designated egress lighting to be on upon loss of building power.

Alternative Solutions

Single Zone

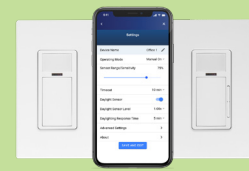

Smart Wallbox Sensors

- Combines occupancy/vacancy sensing with 0-10V dimming or switching
- Integrated photocell for daylighting hold-OFF
- Configure additional capabilities with the Smart Sensor App

Primary and Secondary Daylight Zones



Provolt Room Controller (PRC)

- Integrates occupancy sensing, 0-10V dimming, daylighting

GreenMAX DRC Wired for 2-Zone Plus Daylighting, Typical

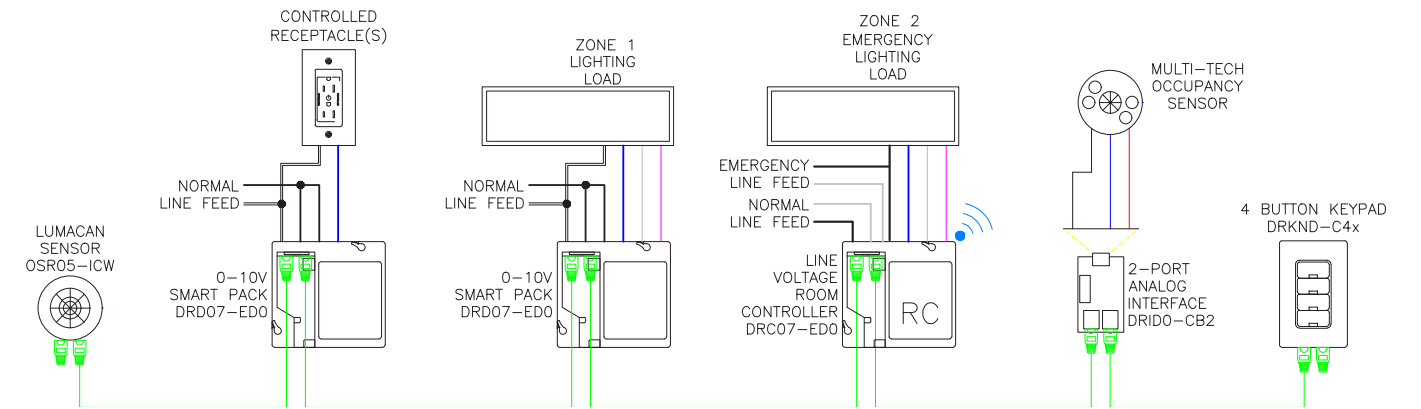

Room Highlights

- 2 Zones
- Occupancy/Vacancy Sensing
- Scene Control
- Daylighting
- Plug Load Control
- Emergency Lighting

What You Will Need

		Quantity
	GreenMAX DRC Line Voltage Room Controller DRC07-ED0	1
	GreenMAX DRC 0-10V Smart Pack DRD07-ED0	2
	GreenMAX DRC Digital Sensor OSR05-ICW	1
	GreenMAX DRC Analog Interface (AI) DRID0-C02	1
	Analog Occupancy Sensor OSCxx-MWW	1
	GreenMAX DRC 4-Button Digital Keypad DRKDN-C4W	1
	Marked Controlled Receptacle 16352-2PW	1

Code Requirements*

2021 IECC	
• Section C405.2.1	• Occupancy Sensors
• Section C405.2.2.1	• Automatic Time Switch Control
• Section C405.2.2.2	• Interior Manual Lighting Controls
	• Light Reduction Controls
• Section C405.2.3	• Daylight Responsive Controls
• Section C405.2.3.1	• Daylight Zone Control
• Section C408.3	• Functional Testing
ASHRAE 90.1 2022	
• Section 8.4.2	• Receptacle/Plug Load Control
• Section 9.4.1	• Lighting Control
• Section 9.4.1.1	• Interior Lighting Control
• Section 9.4.3	• Functional Testing
2022 Title 24, Part 6	
• Section 130.1(a)	• Area Controls
	• Manual ON/OFF
• Section 130.1(b)	• Multi-Level Controls
	• Dimming
• Section 130.1(c)	• Shut-Off Requirements
	• Occupancy Control
	• Partial-ON / Partial-OFF
• Section 130.1(d)	• Daylighting
• Section 130.1(f)	• Control Interactions
• Section 130.5(d)	• Receptacle/Plug Load Control (optional in classrooms)
• Section 110.129(c)	• Demand Management Controls

* Note that code updates are highlighted.

GreenMAX DRC Wireless with Intellect-enabled Fixtures for 2-Zone Plus Daylight Harvesting, Typical

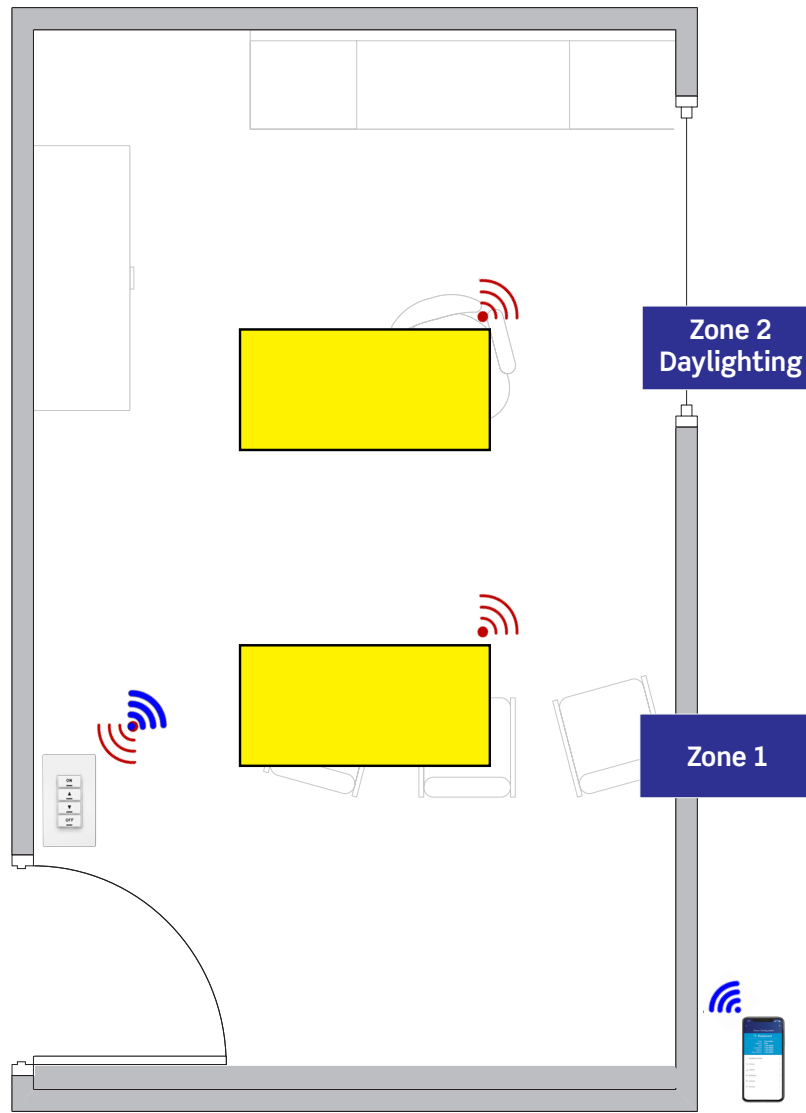

Application Notes

- Wireless interface for configuration, control and status monitoring.
- Room contains two separate zones of lighting, all configured through the GreenMAX DRC App.
- Room has outward-facing windows
- Individual zones respond to ambient light within the space.
- Occupant can access scenes and dimming/switching controls via their smart device, or by utilizing the manual Keypad control.
- Scheduling feature for creating and adding events and schedules to fit the lighting control needs of the space..
- Emergency lighting capable.

Sequence of Operation

- Wi-Fi interface for configuration, control and status monitoring
- All zone 1 and zone 2 lighting auto-on to 50% and controlled receptacles on when occupancy is detected.
- Local control and bi-level control of general lighting from keypad.
- Daylight zone 1 to dim based on photocell input when there is 150W or greater of lighting in the zone and sufficient daylight is available.
- All lighting to turn off automatically when the space is unoccupied after 20 minutes.
- Any designated egress lighting to be on upon loss of building power.

GreenMAX DRC Wireless with Intellect-enabled Fixtures for 2-Zone Plus Daylight Harvesting, Typical

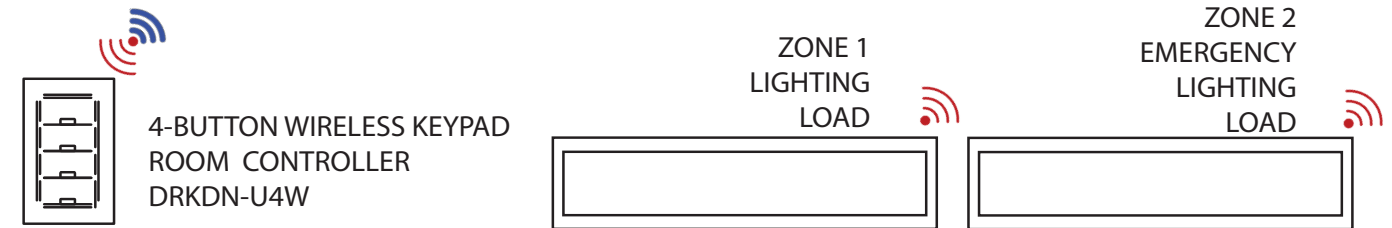

Room Highlights

- Wi-Fi Networking
- 2 Zones
- Occupancy/Vacancy Sensing
- Scheduling
- Scene Control
- Daylighting
- Plug Load Control
- Emergency Lighting

What You Will Need

		Quantity
	GreenMAX DRC 4-Button Wireless Keypad Room Controller DRKDN-U4W	1
	Intellect-enabled Fixture LRTH2x2-LED835UNV-LV01	2

Code Requirements*

2021 IECC	
• Section C405.2.1	• Occupancy Sensors
• Section C405.2.2.1	• Automatic Time Switch Control
• Section C405.2.2.2	• Interior Manual Lighting Controls
	• Light Reduction Controls
• Section C405.2.3	• Daylight Responsive Controls
• Section C405.2.3.1	• Daylight Zone Control
• Section C408.3	• Functional Testing
ASHRAE 90.1 2022	
• Section 9.4.1	• Lighting Control
• Section 9.4.1.1	• Interior Lighting Control
• Section 9.4.3	• Functional Testing
2022 Title 24, Part 6	
• Section 130.1(a)	• Area Controls
	• Manual ON/OFF
• Section 130.1(b)	• Multi-Level Controls
	• Dimming
• Section 130.1(c)	• Shut-Off Requirements
	• Occupancy Control
	• Partial-ON / Partial-OFF
• Section 130.1(d)	• Daylighting
• Section 130.1(f)	• Control Interactions

Alternative Solutions

Single Zone



Smart Wallbox Sensors

- Combines occupancy/vacancy sensing with 0-10V dimming or switching
- Integrated photocell for daylighting hold-OFF
- Configure additional capabilities with the Smart Sensor App

Primary and Secondary Daylight Zones



Smart Ceiling Mount Room Controller (SRC)

- Integrates occupancy sensing, 0-10V dimming, daylighting, partial-ON, partial-OFF and demand response
- Configure using the Smart Sensor App

* Note that code updates are highlighted.

GreenMAX DRC Wireless with 0-10V Dimming, Occupancy/Vacancy Sensing Control and Receptacle Control for 2-Zone Plus Daylighting, Typical

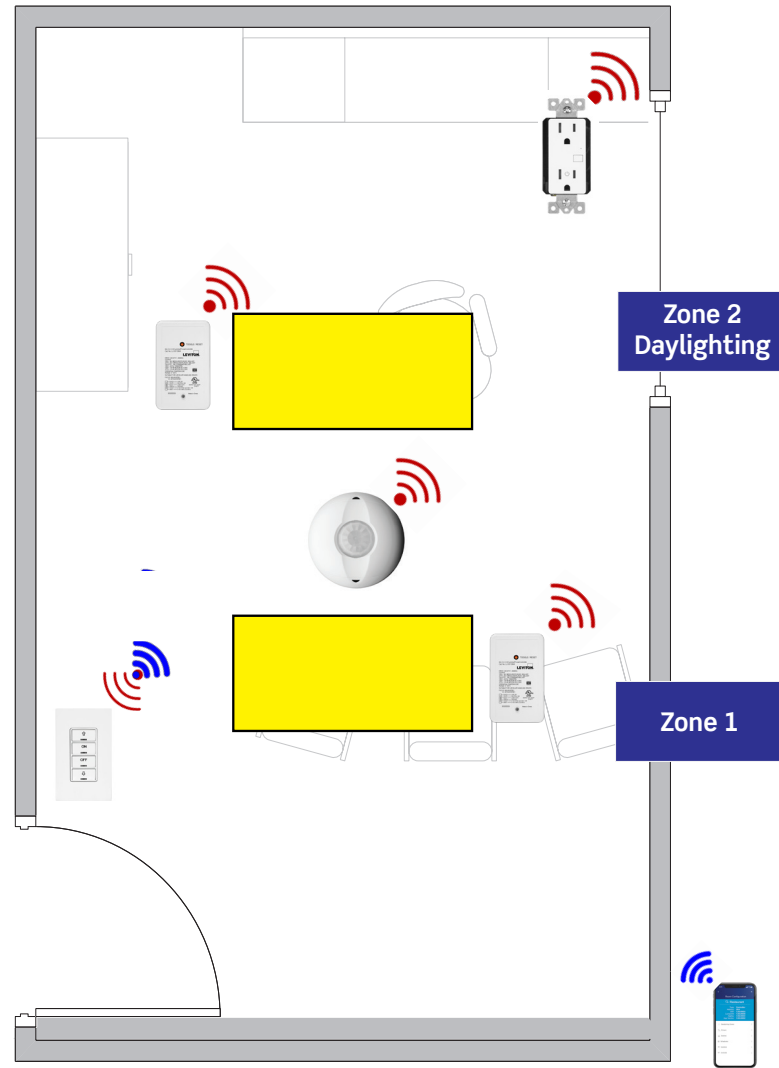

Application Notes

- Wireless interface for configuration, control and status monitoring.
- Room contains two separate zones of lighting, all configured through the GreenMAX DRC App.
- Room has outward-facing windows
- Individual zones respond to ambient light within the space.
- Occupant can access scenes and dimming/switching controls via their smart device, or by utilizing the manual Keypad control.
- Scheduling feature for creating and adding events and schedules to fit the lighting control needs of the space.

Sequence of Operation

- Wi-Fi interface for configuration, control and status monitoring
- All zone 1 and zone 2 lighting auto-on to 50%.
- Local control and bi-level control of general lighting from keypad.
- Daylight zone 1 to dim based on photocell input when there is 150W or greater of lighting in the zone and sufficient daylight is available.
- All lighting to turn off automatically when the space is unoccupied after 20 minutes.

GreenMAX DRC Wireless with 0-10V Dimming, Occupancy/Vacancy Sensing Control and Receptacle Control for 2-Zone Plus Daylighting, Typical



Room Highlights

- Wi-Fi Networking
- 2 Zones
- Occupancy/Vacancy Sensing
- Scheduling
- Scene Control
- 0-10V Dimming

What You Will Need

		Quantity
	GreenMAX DRC 4-Button Wireless Keypad Room Controller DRKDN-U4W	1
	Wireless 10A, 0-10V Dimming Power Pack LU107-DNW	2
	Zigbee PIR Occupancy Sensor & Photocell ZC015-BIW	1
	Zigbee Controlled Receptacle ZSTLR-1HW	Varies

Code Requirements*

2021 IECC	
• Section C405.2.1	• Occupancy Sensors
• Section C405.2.2.1	• Automatic Time Switch Control
• Section C405.2.2.2	• Interior Manual Lighting Controls
	• Light Reduction Controls
• Section C405.2.3	• Daylight Responsive Controls
• Section C405.2.3.1	• Daylight Zone Control
• Section C408.3	• Functional Testing
• Section C405.2.4	• Specific Application Controls—Receptacle Controls
ASHRAE 90.1 2022	
• Section 8.4.2	• Receptacle/Plug Load Control
• Section 9.4.1	• Lighting Control
• Section 9.4.1.1	• Interior Lighting Control
• Section 9.4.3	• Functional Testing
2022 Title 24, Part 6	
• Section 130.1(a)	• Area Controls
	• Manual ON/OFF
• Section 130.1(b)	• Multi-Level Controls
	• Dimming
• Section 130.1(c)	• Shut-Off Requirements
	• Occupancy Control
	• Partial-ON / Partial-OFF
• Section 130.1(d)	• Daylighting
• Section 130.1(f)	• Control Interactions
• Section 130.5(d)	• Receptacle/Plug Load Control

Alternative Solutions

Single Zone

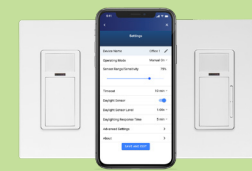

Smart Wallbox Sensors

- Combines occupancy/vacancy sensing with 0-10V dimming or switching
- Integrated photocell for daylighting hold-OFF
- Configure additional capabilities with the Smart Sensor App

Primary and Secondary Daylight Zones



Smart Ceiling Mount Room Controller (SRC)

- Integrates occupancy sensing, 0-10V dimming, daylighting, partial-ON, partial-OFF and demand response
- Configure using the Smart Sensor App

* Note that code updates are highlighted.

GreenMAX DRC Wired for 3-Zone Plus Daylighting, Typical

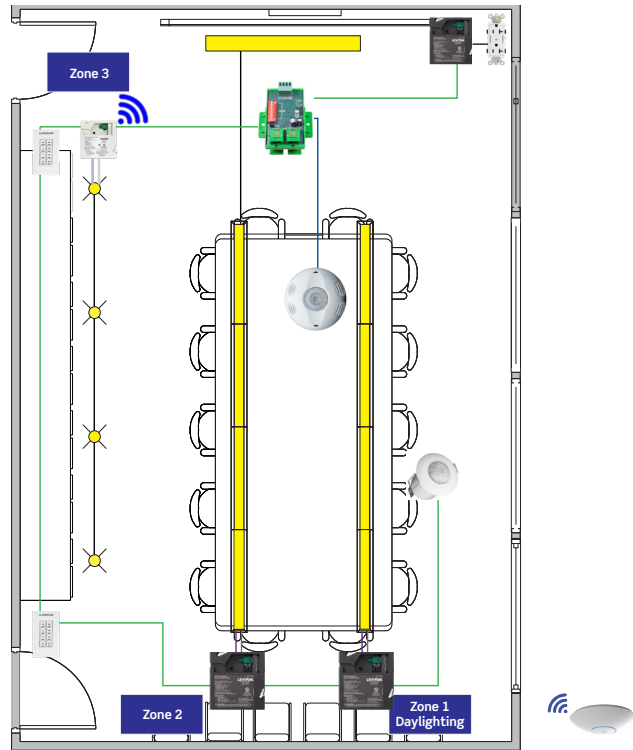

For a networked system, connect spaces via WiFi with the App.

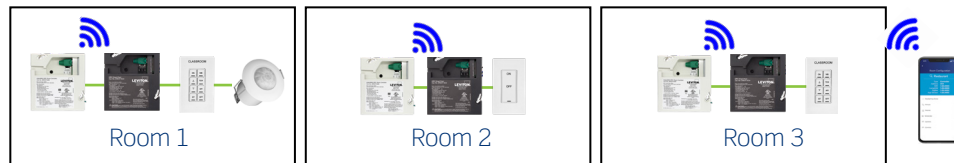

Application Notes

- Space contains three separate zones of lighting, all configured through the GreenMAX DRC App.
- Zones can be rearranged, combined, or deleted with any changes to the usage or setup of the area.
- Multi-tech sensors continually monitor the area and switch all lighting, regardless of zone, off when the area is vacant, and are sensitive enough to detect minor movements, to prevent false-offs
- Emergency lighting capable.

Sequence of Operation

- All zones 1, 2, and 3 manual on with keypads, and controlled receptacles auto-on when occupancy is detected.
- Local control, bi-level control, and any required scene control of general lighting from keypads.
- Daylight zone 3 to dim based on photocell input when there is 150W or greater of lighting in the zone and sufficient daylight is available.
- All lighting and controlled receptacles to turn off automatically when the space is unoccupied after 20 minutes.
- Any designated egress lighting to be on upon loss of building power.

GreenMAX DRC Wired for 3-Zone Plus Daylighting, Typical

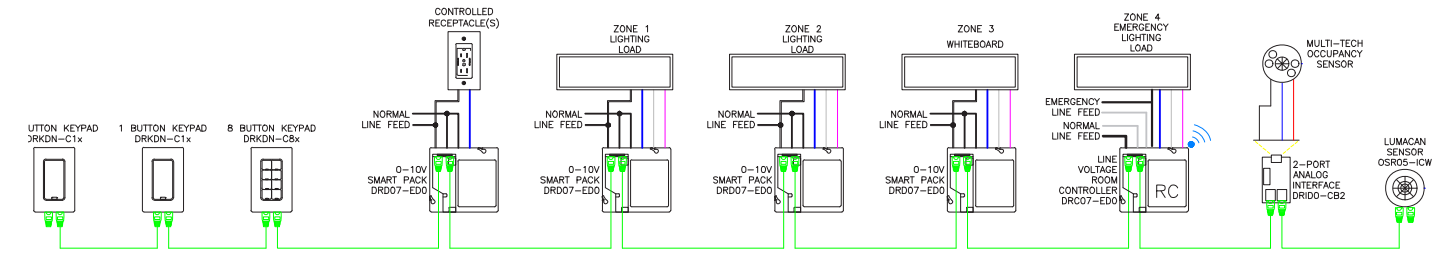

Room Highlights

- 3 Zones
- Occupancy/Vacancy Sensing
- Scene Control
- Daylighting
- Multi-Way Switching
- Plug Load Control
- Emergency Lighting

What You Will Need

		Quantity
	GreenMAX DRC Line Voltage Room Controller DRC07-ED0	1
	GreenMAX DRC 0-10V Smart Pack DRD07-ED0	3
	GreenMAX DRC Digital Sensor OSR05-ICW	1
	GreenMAX DRC Analog Interface (AI) DRID0-C02	1
	Analog Occupancy Sensor OSCxx-MWW	1
	GreenMAX DRC 8-Button Digital Keypad DRKDN-C8W	2
	Marked Controlled Receptacles 16352-2PW	1

Code Requirements*

2021 IECC	
• Section C405.2.1	• Occupancy Sensors
• Section C405.2.2.1	• Automatic Time Switch Control
• Section C405.2.2.2	• Interior Manual Lighting Controls
	• Light Reduction Controls
• Section C405.2.3	• Daylight Responsive Controls
• Section C405.2.3.1	• Daylight Zone Control
• Section C408.3	• Functional Testing
ASHRAE 90.1 2022	
• Section 8.4.2	• Receptacle/Plug Load Control
• Section 9.4.1	• Lighting Control
• Section 9.4.1.1	• Interior Lighting Control
• Section 9.4.3	• Functional Testing
2022 Title 24, Part 6	
• Section 130.1(a)	• Area Controls
	• Manual ON/OFF
• Section 130.1(b)	• Multi-Level Controls
	• Dimming
• Section 130.1(c)	• Shut-Off Requirements
	• Occupancy Control
	• Partial-ON / Partial-OFF
• Section 130.1(d)	• Daylighting
• Section 130.1(f)	• Control Interactions
• Section 130.5(d)	• Receptacle/Plug Load Control (optional in classrooms)
• Section 110.129(c)	• Demand Management Controls

Alternative Solutions

Wireless Multi-Zone Control



GreenMAX DRC Wireless Devices

- Add wireless control to any ON/OFF or 0-10V or phase cut dimming device
- Configure using the GreenMAX DRC App
- Add wireless occupancy/vacancy sensors and photocells with no additional wiring needed

* Note that code updates are highlighted.

GreenMAX DRC Wireless with Intellect-enabled Fixtures and Wireless Devices with Single Zone 0-10V, Relay Control, and Receptacle Control for 3-Zone Plus Daylighting, Typical

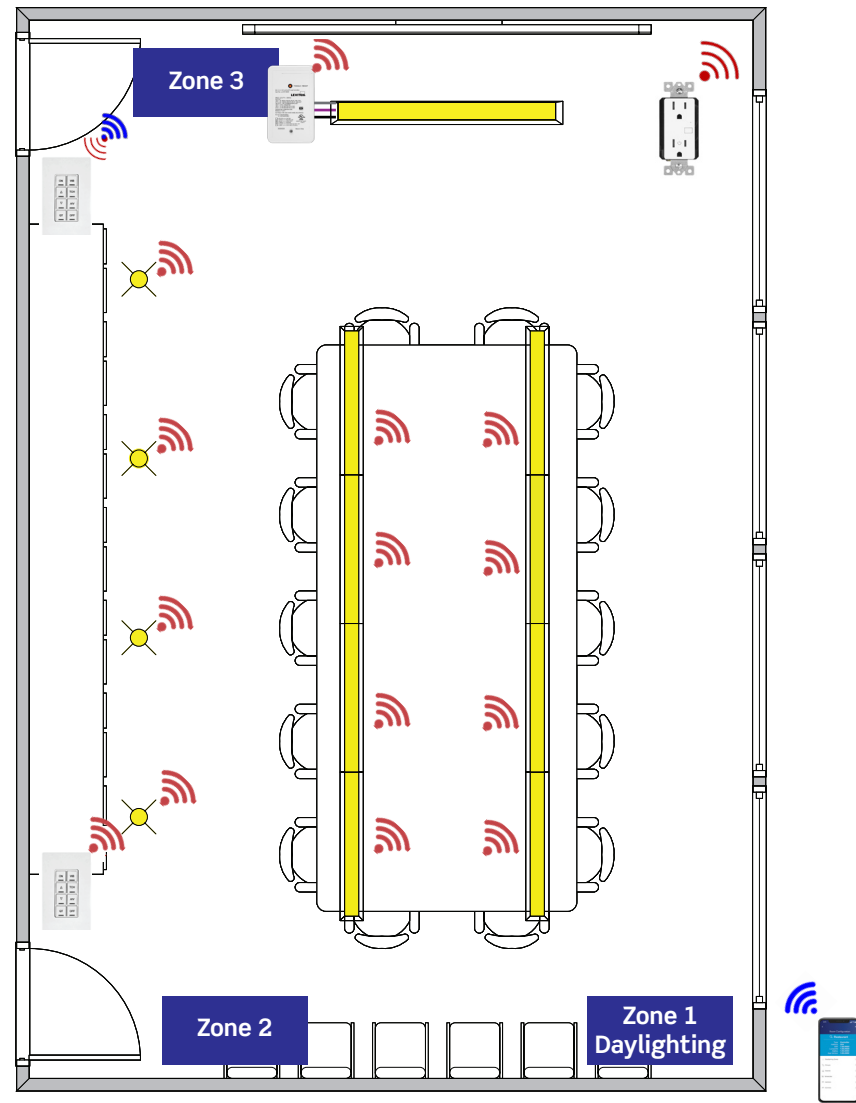

Application Notes

- Wireless interface for configuration, control and status monitoring.
- Space contains three separate zones of lighting, all configured through the GreenMAX DRC App.
- Zones can be rearranged, combined, or deleted with any changes to the usage or setup of the area.
- Scheduling feature for creating and adding events and schedules to fit the lighting control needs of the space.
- Emergency lighting capable.

Sequence of Operation

- Wi-Fi interface for configuration, control and status with keypads, and controlled receptacles auto-on when occupancy is detected.
- Local control, bi-level control, and any required scene control of general lighting from keypads.
- Daylight zone 3 to dim based on photocell input when there is 150W or greater of lighting in the zone and sufficient daylight is available.
- All lighting and controlled receptacles to turn off automatically when the space is unoccupied after 20 minutes.
- Any designated egress lighting to be on upon loss of building power.

GreenMAX DRC Wireless with Intellect-enabled Fixtures and Wireless Devices with Single Zone 0-10V, Relay Control, and Receptacle Control for 3-Zone Plus Daylighting, Typical

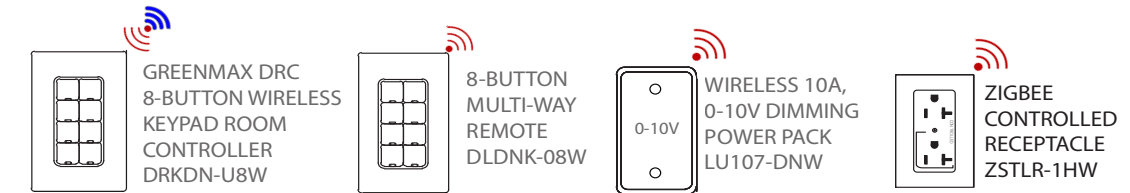

Room Highlights

- Wi-Fi Networking
- 3 Zones
- Occupancy/Vacancy Sensing
- Scheduling
- Scene Control
- Daylighting
- Multi-Way Switching
- Plug Load Control
- Emergency Lighting

What You Will Need

		Quantity
	GreenMAX DRC 8-Button Wireless Keypad Room Controller DRKDN-U8W	1
	8-Button Wireless Multi-Way Remote DLDNK-08W	1
	Wireless 20A ON/OFF Switching Power Pack LU20S-DNW	1
	Intellect-enabled Fixture ALRM-XX-LED	8
	Zigbee Controlled Receptacle ZSTLR-1HW	Varies
	Intellect-enabled Fixture R4NCIE	4

Code Requirements*

2021 IECC	
• Section C405.2.1	• Occupancy Sensors
• Section C405.2.2.1	• Automatic Time Switch Control
• Section C405.2.3.1	• Daylight Zone Control
• Section C405.2.4	• Daylight Responsive Controls
• Section C405.2.6	• Interior Manual Lighting Controls
	• Light Reduction Controls
• Section C408.3	• Functional Testing
• Section C405.11.1	• Automatic Receptacle Controls
ASHRAE 90.1 2022	
• Section 8.4.2	• Receptacle/Plug Load Control
• Section 9.4.1	• Lighting Control
• Section 9.4.1.1	• Interior Lighting Control
• Section 9.4.3	• Functional Testing
2022 Title 24, Part 6	
• Section 130.1(a)	• Area Controls
	• Manual ON/OFF
• Section 130.1(b)	• Multi-Level Controls
	• Dimming
• Section 130.1(c)	• Shut-Off Requirements
	• Occupancy Control
	• Partial-ON / Partial-OFF
• Section 130.1(d)	• Daylighting
• Section 130.1(f)	• Control Interactions
• Section 130.5(d)	• Receptacle/Plug Load Control (optional in classrooms)
• Section 110.129(c)	• Demand Management Controls

Alternative Solution

Primary and Secondary Daylight Zone

Smart Ceiling Mount Room Controller (SRC)

- Integrates occupancy sensing, 0-10V dimming, daylighting, partial-ON, partial-OFF and demand response
- Configure using the Smart Sensor App

* Note that code updates are highlighted.

GreenMAX DRC Wireless with 0-10V Dimming, Scene Control, Occupancy/Vacancy Sensing, and Receptacle Control for 3 Zone Plus Daylighting, Typical

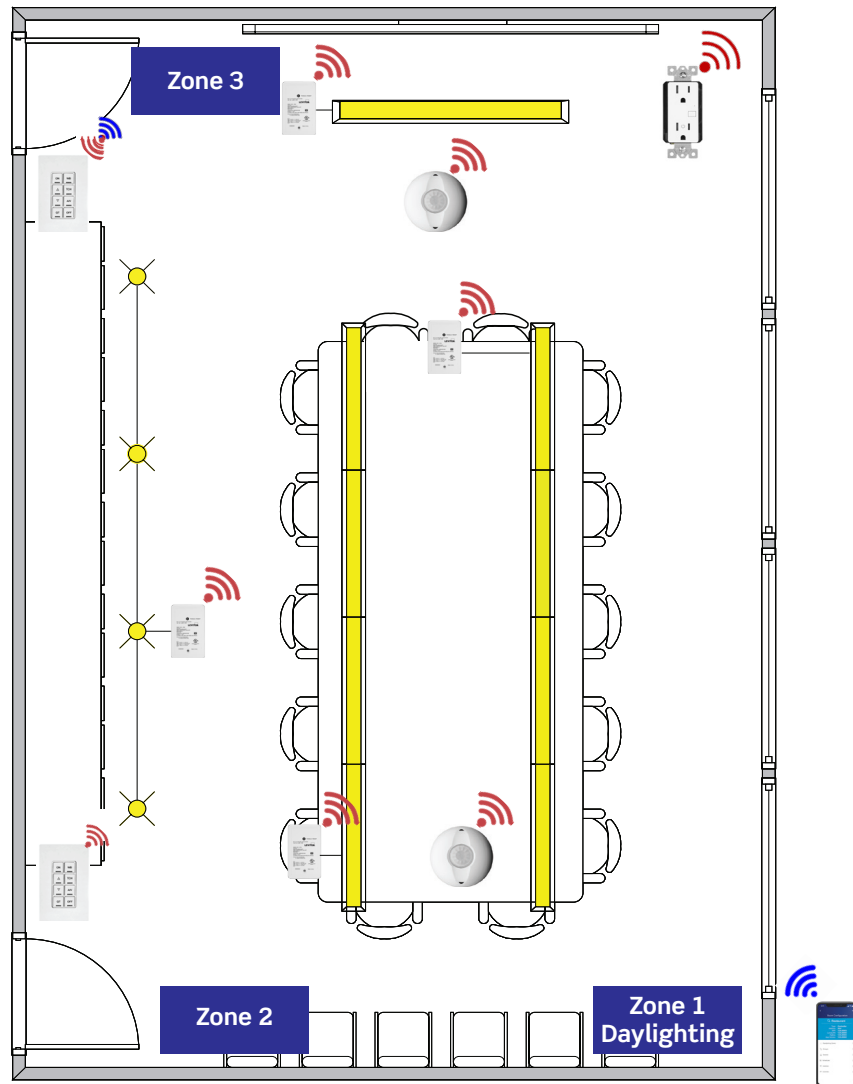

Application Notes

- Wireless interface for configuration, control and status monitoring.
- Space contains three separate zones of lighting, all configured through the GreenMAX DRC App.
- Zones can be rearranged, combined, or deleted with any changes to the usage or setup of the area.
- Multi-tech sensors continually monitor the area and switch all lighting, regardless of zone, off when the area is vacant, and are sensitive enough to detect minor movements, to prevent false-offs
- Scheduling feature for creating and adding events and schedules to fit the lighting control needs of the space.
- Emergency lighting capable.

Sequence of Operation

- Wi-Fi interface for configuration, control and status with keypads, and controlled receptacles auto-on when occupancy is detected.
- Local control, bi-level control, and any required scene control of general lighting from keypads.
- Daylight zone 3 to dim based on photocell input when there is 150W or greater of lighting in the zone and sufficient daylight is available.
- All lighting and controlled receptacles to turn off automatically when the space is unoccupied after 20 minutes.
- Any designated egress lighting to be on upon loss of building power.

Alternative Solution

Primary and Secondary Daylight Zone Control



Smart Ceiling Mount Room Controller (SRC)

- Integrates occupancy sensing, 0-10V dimming, daylighting, partial-ON, partial-OFF and demand response
- Configure using the Smart Sensor App

GreenMAX DRC Wireless with 0-10V Dimming, Scene Control, Occupancy/Vacancy Sensing, and Receptacle Control for 3 Zone Plus Daylighting, Typical



Room Highlights

- Wi-Fi Networking
- 3 Zones
- Occupancy/Vacancy Sensing
- Scene Control
- Scheduling
- Daylighting
- Multi-Way Switching
- Plug Load Control
- Emergency Lighting

What You Will Need

	Quantity
GreenMAX DRC 8-Button Wireless Keypad Room Controller DRKDN-U8W	1
8-Button Wireless Multi-Way Remote DLDNK-08W	1
Wireless 10A, 0-10V Dimming Power Pack LU107-DNW	4
Zigbee PIR Occupancy Sensor & Photocell ZC015-BIW	2
Zigbee Controlled Receptacle ZSTLR-1HW	Varies

Code Requirements*

2021 IECC	
• Section C405.2.1	• Occupancy Sensors
• Section C405.2.2.1	• Automatic Time Switch Control
• Section C405.2.2.2	• Interior Manual Lighting Controls
	• Light Reduction Controls
• Section C405.2.3	• Daylight Responsive Controls
• Section C405.2.3.1	• Daylight Zone Control
• Section C408.3	• Functional Testing
• Section C405.2.4	• Specific Application Controls—Receptacle Controls
ASHRAE 90.1 2022	
• Section 8.4.2	• Receptacle/Plug Load Control
• Section 9.4.1	• Lighting Control
• Section 9.4.1.1	• Interior Lighting Control
• Section 9.4.3	• Functional Testing
2022 Title 24, Part 6	
• Section 130.1(a)	• Area Controls
	• Manual ON/OFF
• Section 130.1(b)	• Multi-Level Controls
	• Dimming
• Section 130.1(c)	• Shut-Off Requirements
	• Occupancy Control
	• Partial-ON / Partial-OFF
• Section 130.1(d)	• Daylighting
• Section 130.1(f)	• Control Interactions
• Section 130.5(d)	• Receptacle/Plug Load Control (optional in classrooms)
• Section 110.129(c)	• Demand Management Controls
• Section 130.5(d)	• Receptacle/Plug Load Control (optional in classrooms)

* Note that code updates are highlighted.

GreenMAX DRC Wired for 6-Zone Plus Daylighting, Typical

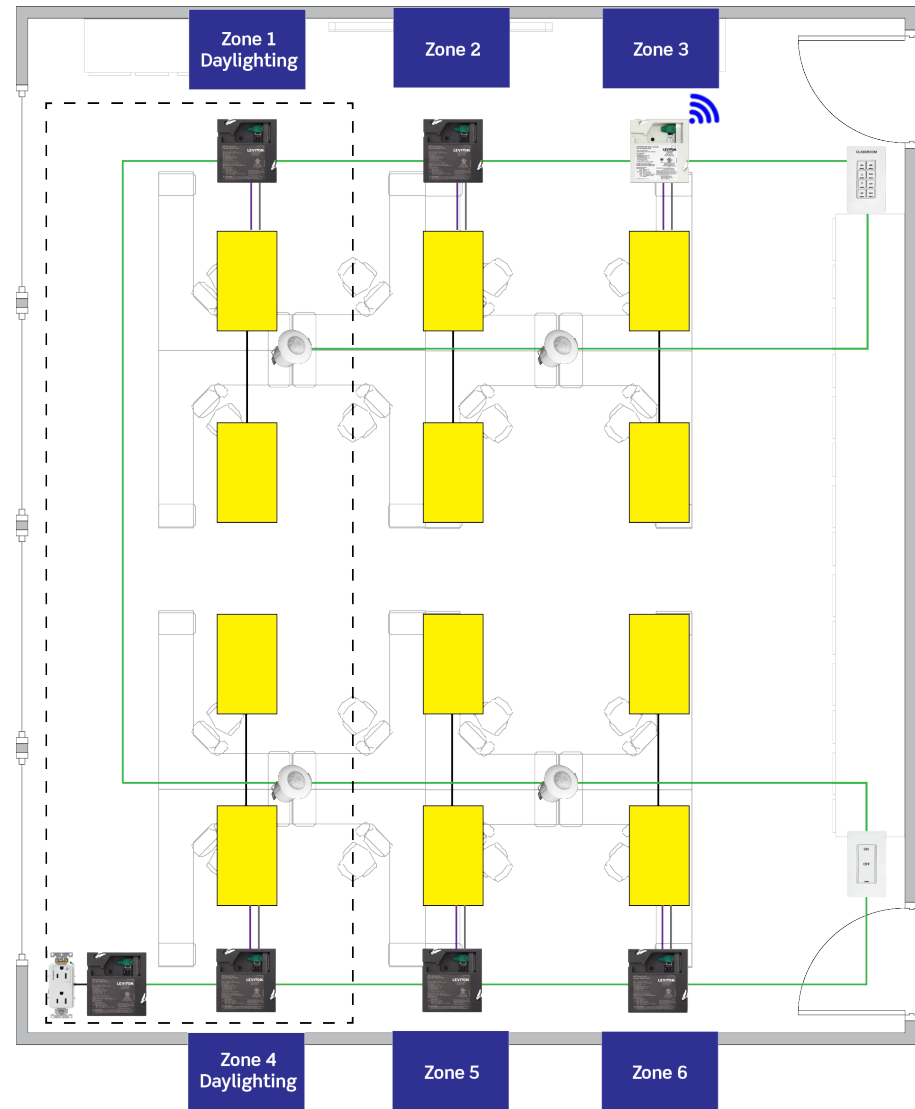

For a networked system, connect spaces via WiFi with the App.



Alternative Solution

Wireless Multi-Zone Control



GreenMAX DRC with Intellect-enabled Fixtures

- Virtually any fixture can be Intellect-enabled with wireless occupancy/vacancy sensing and daylighting capabilities
- GreenMAX DRC Keypad Room Controllers add manual and scene control
- Configure using the GreenMAX DRC App

Application Notes

- Space contains six separate zones of lighting, all configured through the GreenMAX DRC App.
- Zones can be rearranged, combined, or deleted with any changes to the usage or setup of the area.
- Passive infrared sensors continually monitor the area and switch all lighting, regardless of zone, off when the area is vacant, and are sensitive enough to detect minor movements, to prevent false-offs
- Emergency lighting capable.

Sequence of Operation

- All lighting and controlled receptacles in zones 1, 2, 3, 4, 5, and 6 automatically turned on upon occupancy.
- Daylight zones 1 and 4 to be dimmed via photocell when sufficient daylight is available.
- Areas within the space to be divided into 600SF or smaller occupancy zones. For example: area 1 includes zones 1 and 2, area 2 includes zones 4 and 5.
- When any occupancy area is empty, lighting power in that area to be reduced by at least 80%, and daylight zones become inactive within 20 minutes of occupant leaving the space. Lighting in that area to return to 100% and daylight controls to be restored upon the area being reoccupied.
- All light to be turned off via occupancy sensor when zones 1-6 are unoccupied for 20 minutes.
- Local control and any required scene control of general lighting from keypads.
- Any designated egress lighting to be on upon loss of building power.

GreenMAX DRC Wired for 6-Zone Plus Daylighting, Typical

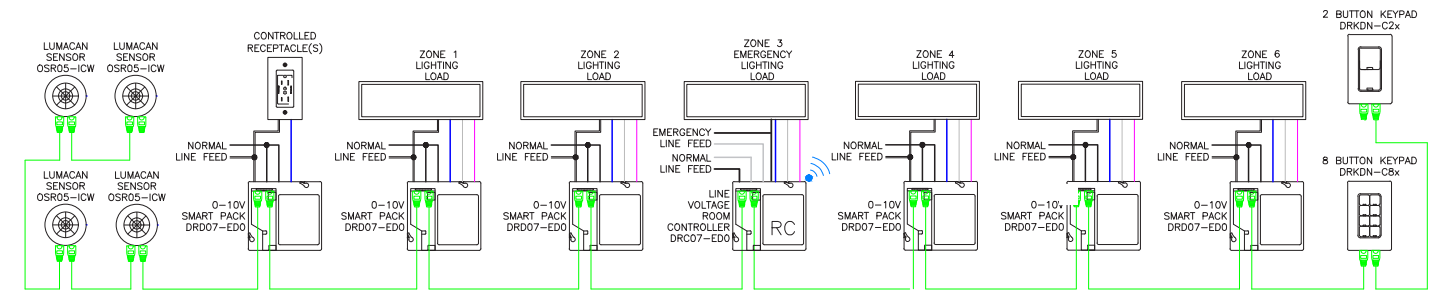

Room Highlights

- 6 Zones
- 2 Occupancy Zones
- Occupancy/Vacancy Sensing
- Scene Control
- Daylighting
- Multi-Way Switching
- Plug Load Control
- Emergency Lighting

What You Will Need

What You Will Need	Quantity
GreenMAX DRC Line Voltage Room Controller DRC07-ED0	1
GreenMAX DRC 0-10V Smart Pack DRD07-EDO	6
GreenMAX DRC Digital Sensor OSR05-ICW	4
GreenMAX DRC 8-Button Digital Keypad DRKDN-C8W	1
GreenMAX DRC 1-Button Digital Keypad DRKDN-C1W	1
Marked Controlled Receptacles 16352-2PW	1

Code Requirements*

2021 IECC	
• Section C405.2.1	• Occupancy Sensors
• Section C405.2.2.1	• Automatic Time Switch Control
• Section C405.2.2.2	• Interior Manual Lighting Controls
	• Light Reduction Controls
• Section C405.2.3	• Daylight Responsive Controls
• Section C405.2.3.1	• Daylight Zone Control
• Section C408.3	• Functional Testing
ASHRAE 90.1 2022	
• Section 8.4.2	• Receptacle/Plug Load Control
• Section 9.4.1	• Lighting Control
• Section 9.4.1.1	• Interior Lighting Control
• Section 9.4.3	• Functional Testing
2022 Title 24, Part 6	
• Section 130.1(a)	• Area Controls
	• Manual ON/OFF
• Section 130.1(b)	• Multi-Level Controls
	• Dimming
• Section 130.1(c)	• Shut-Off Requirements
	• Occupancy Control
	• Partial-ON / Partial-OFF
• Section 130.1(d)	• Daylighting
• Section 130.1(f)	• Control Interactions
• Section 130.5(d)	• Receptacle/Plug Load Control (optional in classrooms)
• Section 110.129(c)	• Demand Management Controls

* Note that code updates are highlighted.

GreenMAX DRC Wireless for 6-Zone with Intellect-enabled Fixtures and Wireless Devices Plus Daylighting, Typical

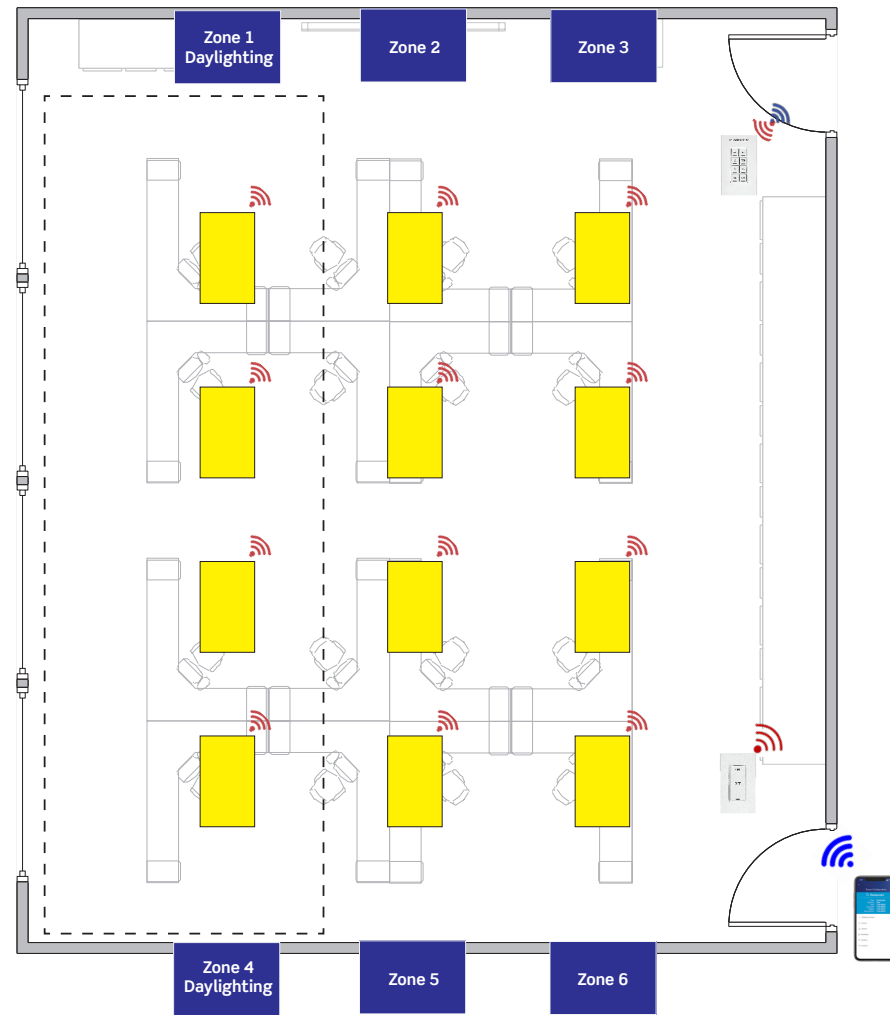

Application Notes

- Wireless interface for configuration, control and status monitoring.
- Space contains six separate zones of lighting, all configured through the GreenMAX DRC App to prevent false-offs
- Scheduling feature for creating and adding events and schedules to fit the lighting control needs of the space.
- Emergency lighting capable.

Sequence of Operation

- All lighting and controlled receptacles in zones 1, 2, 3, 4, 5, and 6 automatically turned on upon occupancy.
- Daylight zones 1 and 4 to be dimmed via photocell when sufficient daylight is available.
- Areas within the space to be divided into 600SF or smaller occupancy zones. For example: area 1 includes zones 1 and 2, area 2 includes zones 4 and 5.
- When any occupancy area is empty, lighting power in that area to be reduced by at least 80%, and daylight zones become inactive within 20 minutes of occupant leaving the space. Lighting in that area to return to 100% and daylight controls to be restored upon the area being reoccupied.
- All light to be turned off via occupancy sensor when zones 1-6 are unoccupied for 20 minutes.
- Local control and any required scene control of general lighting from keypads.

Alternative Solution

Individual Wireless Fixture Control



Wireless Devices

- Add wireless control to any ON/OFF or 0-10V or phase cut dimming device
- Configure using the GreenMAX DRC App
- Add wireless occupancy/vacancy sensors and photocells with no additional wiring needed

GreenMAX DRC Wireless for 6-Zone with Intellect-enabled Fixtures and Wireless Devices Plus Daylighting, Typical

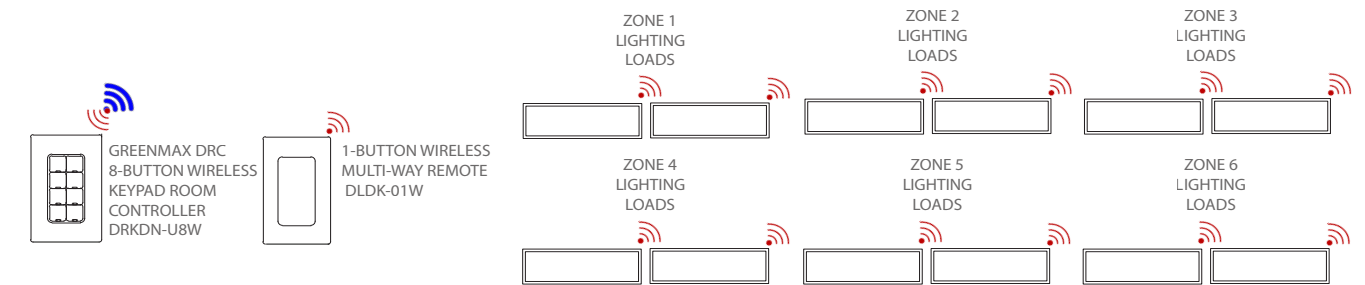

Room Highlights

- Wi-Fi Networking
- 6 Zones
- 2 Occupancy Zones
- Occupancy/Vacancy Sensing
- Scheduling

- Scene Control
- Daylighting
- Multi-Way Switching
- Emergency Lighting

What You Will Need

		Quantity
	8-Button Wireless Keypad Room Controller DRKDN-U8W	1
	1-Button Wireless Multi-Way Remote DLDNK-01W	1
	Intellect-enabled Fixture LRTH2x2-LED835UNV-LV01	12

Code Requirements*

2021 IECC	
• Section C405.2.1	• Occupancy Sensors
• Section C405.2.2.1	• Automatic Time Switch Control
• Section C405.2.2.2	• Interior Manual Lighting Controls
	• Light Reduction Controls
• Section C405.2.3	• Daylight Responsive Controls
• Section C405.2.3.1	• Daylight Zone Control
• Section C408.3	• Functional Testing
ASHRAE 90.1 2022	
• Section 9.4.1	• Lighting Control
• Section 9.4.1.1	• Interior Lighting Control
• Section 9.4.3	• Functional Testing
2022 Title 24, Part 6	
• Section 130.1(a)	• Area Controls
	• Manual ON/OFF
• Section 130.1(b)	• Multi-Level Controls
	• Dimming
• Section 130.1(c)	• Shut-Off Requirements
	• Occupancy Control
	• Partial-ON / Partial-OFF
• Section 130.1(d)	• Daylighting
• Section 130.1(f)	• Control Interactions
• Section 110.129(c)	• Demand Management Controls

* Note that code updates are highlighted.

GreenMAX DRC Wireless for 6 Zone, Plus 0-10V Dimming, Scene Control, Occupancy/Vacancy Sensing, Plug Load Control and Multi-Zone Daylight Harvesting, Typical

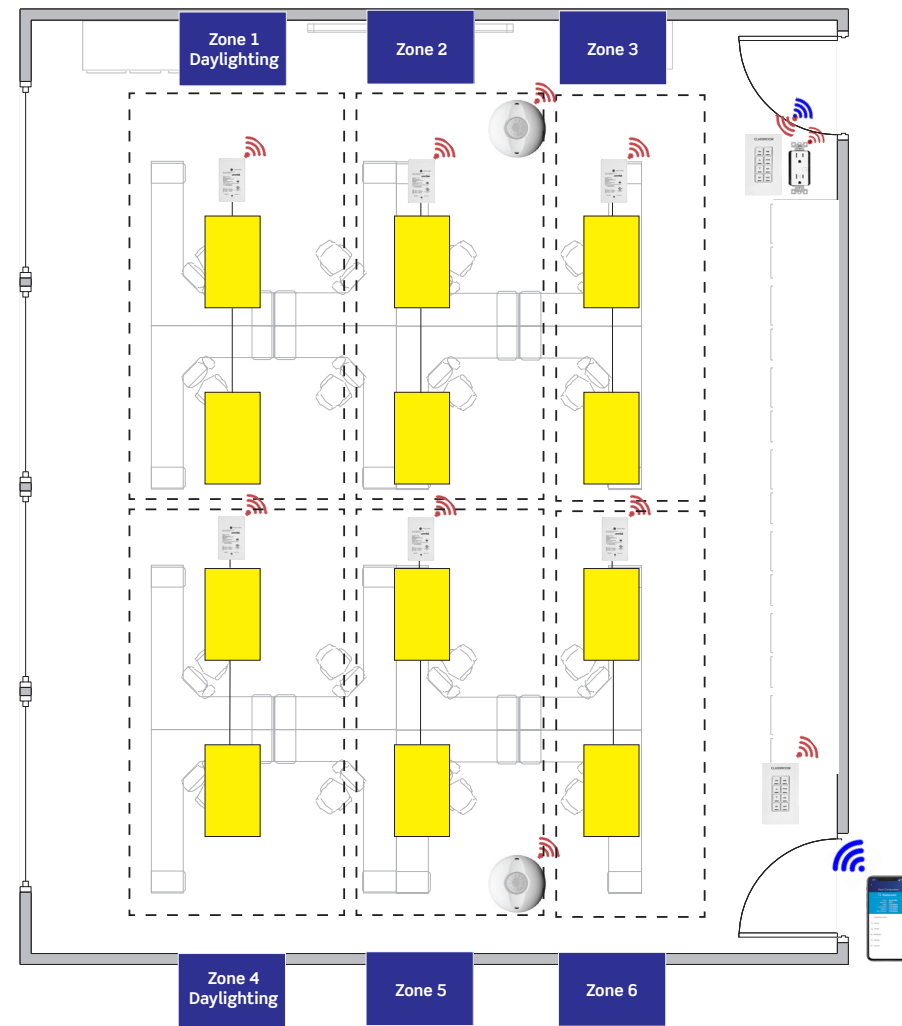

Application Notes

- Wireless interface for configuration, control and status monitoring.
- Space contains six separate zones of lighting, all configured through the GreenMAX DRC App to prevent false-offs
- Scheduling feature for creating and adding events and schedules to fit the lighting control needs of the space.
- Emergency lighting capable.

Sequence of Operation

- All lighting and controlled receptacles in zones 1, 2, 3, 4, 5, and 6 automatically turned on upon occupancy.
- Daylight zones 1 and 4 to be dimmed via photocell when sufficient daylight is available.
- Areas within the space to be divided into 600SF or smaller occupancy zones. For example: area 1 includes zones 1 and 2, area 2 includes zones 4 and 5.
- When any occupancy area is empty, lighting power in that area to be reduced by at least 80%, and daylight zones become inactive within 20 minutes of occupant leaving the space. Lighting in that area to return to 100% and daylight controls to be restored upon the area being reoccupied.
- All light to be turned off via occupancy sensor when zones 1-6 are unoccupied for 20 minutes.
- Local control and any required scene control of general lighting from keypads.

Alternative Solution

Primary and Secondary Daylight Zones

Smart Ceiling Mount Room Controller (SRC)

- Integrates occupancy sensing, 0-10V dimming, daylighting, partial-ON, partial-OFF and demand response
- Configure using the Smart Sensor App

GreenMAX DRC Wireless for 6 Zone, Plus 0-10V Dimming, Scene Control, Occupancy/Vacancy Sensing, Plug Load Control and Multi-Zone Daylight Harvesting, Typical



Room Highlights

- Wi-Fi Networking
- 6 Zones
- 2 Occupancy Zones
- Occupancy/Vacancy Sensing
- Scheduling
- Plug Load Control
- Scene Control
- Multi-Zone Daylight Harvesting
- Multi-Way Switching
- Emergency Lighting

What You Will Need

What You Will Need	Quantity
GreenMAX DRC 8-Button Wireless Keypad Room Controller DRKDN-U8W	1
8-Button Wireless Multi-Way Remote DLDNK-08W	1
Wireless 10A, 0-10V Dimming Power Pack LU107-DNW	6
Zigbee PIR Occupancy Sensor & Photocell ZC015-BIW	2
Zigbee Controlled Receptacle ZSTLR-1HW	Varies

Code Requirements*

2021 IECC	
• Section C405.2.1	• Occupancy Sensors
• Section C405.2.2.1	• Automatic Time Switch Control
• Section C405.2.2.2	• Interior Manual Lighting Controls
	• Light Reduction Controls
• Section C405.2.3	• Daylight Responsive Controls
• Section C405.2.3.1	• Daylight Zone Control
• Section C408.3	• Functional Testing
• Section C405.2.4	• Specific Application Controls—Receptacle Controls
ASHRAE 90.1 2022	
• Section 8.4.2	• Receptacle/Plug Load Control
• Section 9.4.1	• Lighting Control
• Section 9.4.1.1	• Interior Lighting Control
• Section 9.4.3	• Functional Testing
2022 Title 24, Part 6	
• Section 130.1(a)	• Area Controls
	• Manual ON/OFF
• Section 130.1(b)	• Multi-Level Controls
	• Dimming
• Section 130.1(c)	• Shut-Off Requirements
	• Occupancy Control
	• Partial-ON / Partial-OFF
• Section 130.1(d)	• Daylighting
• Section 130.1(f)	• Control Interactions
• Section 130.5(d)	• Receptacle/Plug Load Control (optional in classrooms)
• Section 110.129(c)	• Demand Management Controls

* Note that code updates are highlighted.

GreenMAX DRC Wired for 9-Zone Plus Daylighting, Typical

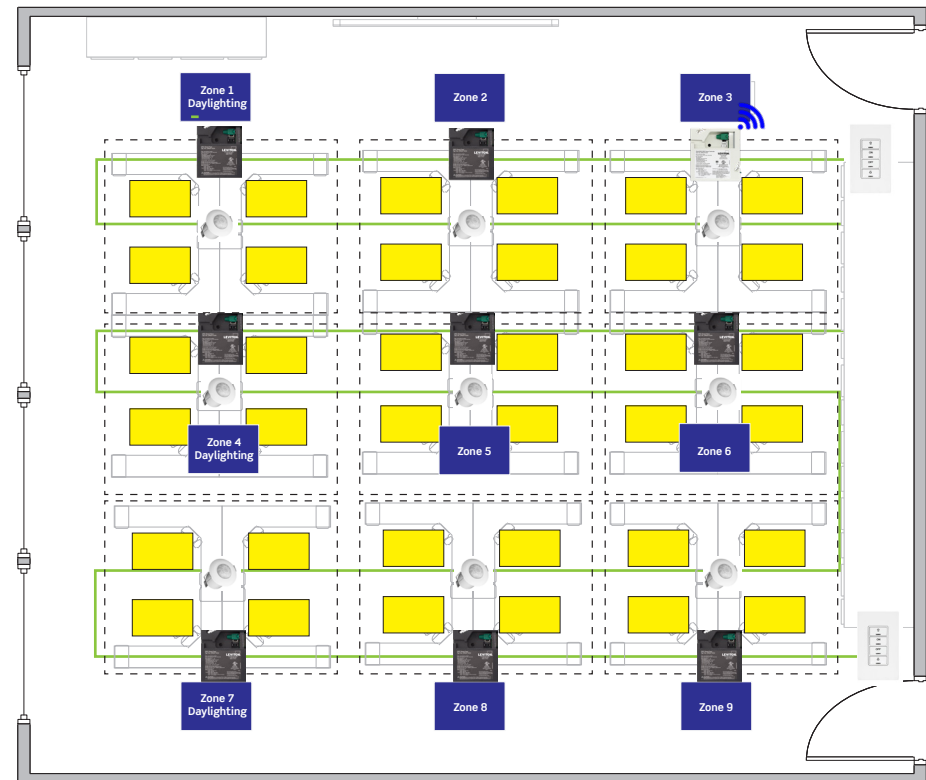

For a networked system, connect spaces via WiFi with the App.



Application Notes

- Room contains nine separate zones of lighting and three daylighting zones all configured through the GreenMAX DRC App.
- Zones can be rearranged, combined, or deleted with any changes to the usage or setup of the area.
- Passive infrared sensors continually monitor the area and switch all lighting, regardless of zone, off when the area is vacant, and are sensitive enough to detect minor movements, to prevent false-offs
- Emergency lighting capable.

Sequence of Operation

- All lighting in zones 1-9 automatically turned on upon occupancy.
- Daylight zones 1, 4, and 7 to be dimmed via photocell when sufficient daylight is available.
- Areas within the space to be divided into 600SF or smaller occupancy zones.
- When any occupancy area is empty, lighting power in that area to be reduced by at least 80%, and daylight zones become inactive within 20 minutes of occupant leaving the space. Lighting in that area to return to 100% and daylight controls to be restored upon the area being reoccupied.
- All light to be turned off via occupancy sensor when zones 1-9 are unoccupied for 20 minutes.

GreenMAX DRC Wired for 9-Zone Plus Daylighting, Typical

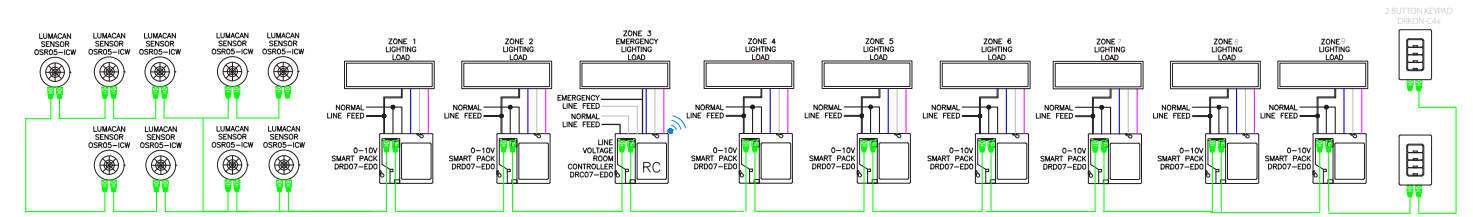

Room Highlights

- 9 Zones
- 9 Occupancy Zones
- Occupancy/Vacancy Sensing
- Scene Control
- Daylighting
- Multi-Way Switching
- Emergency Lighting

What You Will Need

		Quantity
	GreenMAX DRC Line Voltage Room Controller DRC07-ED0	9
	GreenMAX DRC 0-10V Smart Pack DRD07-ED0	8
	GreenMAX DRC Digital Sensor OSR05-ICW	9
	GreenMAX DRC 4-Button Digital Keypad DRKDN-C4W	2

Code Requirements*

2021 IECC	
• Section C405.2.1	• Occupancy Sensors
• Section C405.2.2.1	• Automatic Time Switch Control
• Section C405.2.2.2	• Interior Manual Lighting Controls
	• Light Reduction Controls
• Section C405.2.3	• Daylight Responsive Controls
• Section C405.2.3.1	• Daylight Zone Control
• Section C408.3	• Functional Testing
ASHRAE 90.1 2022	
• Section 9.4.1	• Lighting Control
• Section 9.4.1.1	• Interior Lighting Control
• Section 9.4.3	• Functional Testing
2022 Title 24, Part 6	
• Section 130.1(a)	• Area Controls
	• Manual ON/OFF
• Section 130.1(b)	• Multi-Level Controls
	• Dimming
• Section 130.1(c)	• Shut-Off Requirements
	• Occupancy Control
	• Partial-ON / Partial-OFF
• Section 130.1(d)	• Daylighting
• Section 130.1(f)	• Control Interactions
• Section 110.129(c)	• Demand Management Controls

Alternative Solution

Individual Wireless Fixture Control



Wireless Devices

- Add wireless control to any ON/OFF or 0-10V or phase cut dimming device
- Configure using the GreenMAX DRC App
- Add wireless occupancy/vacancy sensors and photocells with no additional wiring needed

* Note that code updates are highlighted.

GreenMAX DRC Wireless with Intellect-enabled Fixtures for 9-Zone Plus Daylighting, Typical

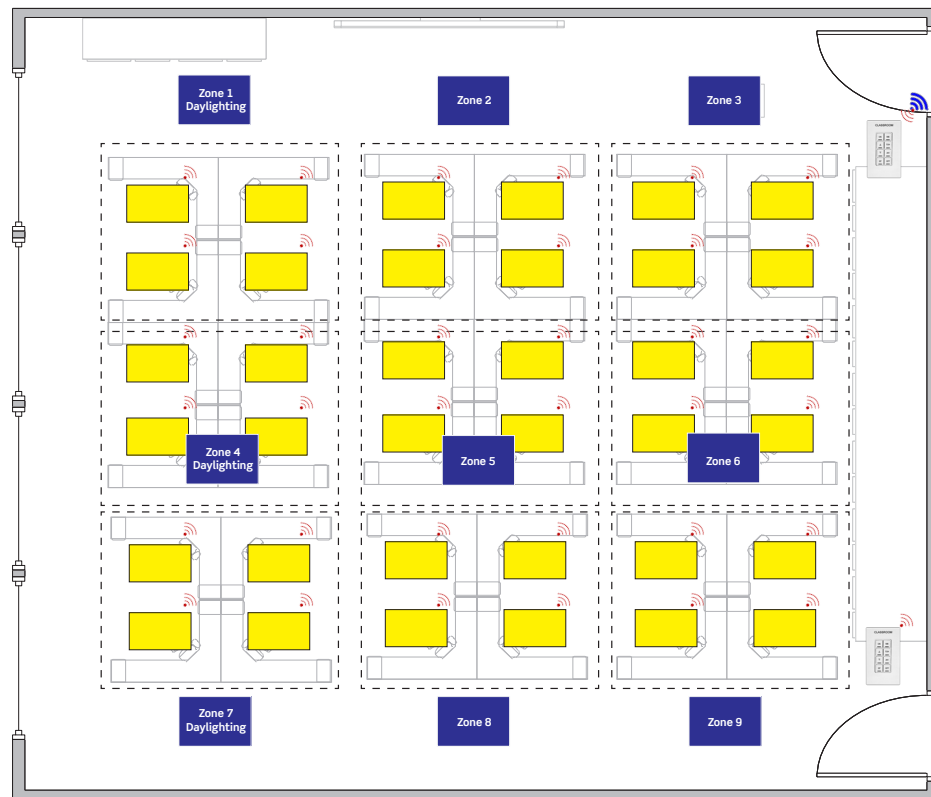

Application Notes

- Wireless interface for configuration, control and status monitoring.
- Room contains nine separate zones of lighting and three daylighting zones all configured through the GreenMAX DRC App.
- Zones can be rearranged, combined, or deleted with any changes to the usage or setup of the area.
- Passive infrared sensors continually monitor the area and switch all lighting, regardless of zone, off when the area is vacant, and are sensitive enough to detect minor movements to prevent false-offs.
- Scheduling feature for creating and adding events and schedules to fit the lighting control needs of the space.
- Emergency lighting capable.

Sequence of Operation

- Wi-Fi interface for configuration, control and status monitoring.
- All lighting in zones 1-9 automatically turned on upon occupancy.
- Daylight zones 1, 4, and 9 to be dimmed via photocell when sufficient daylight is available.
- When any occupancy area is empty, lighting power in that area to be reduced by at least 80%, and daylight zones become inactive within 20 minutes of occupant leaving the space.
- Lighting in that area to return to 100% and daylight controls to be restored upon the area being reoccupied.
- All light to be turned off via occupancy sensor when zones 1-9 are unoccupied for 20 minutes.

Alternative Solution

Primary and Secondary Daylight Zones



Smart Ceiling Mount Room Controller (SRC)

- Integrates occupancy sensing, 0-10V dimming, daylighting, partial-ON, partial-OFF and demand response
- Configure using the Smart Sensor App

GreenMAX DRC Wireless with Intellect-enabled Fixtures for 9-Zone Plus Daylighting, Typical

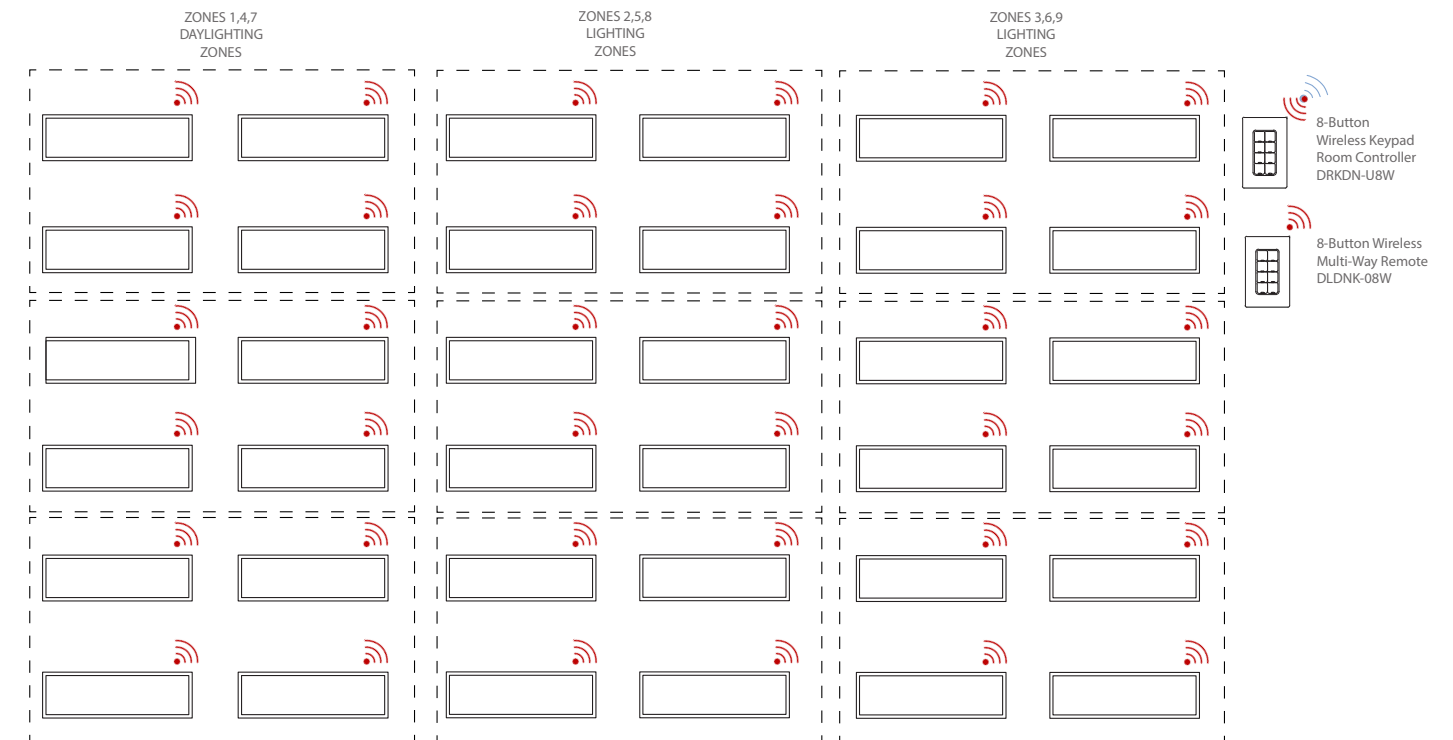

Room Highlights

- Wi-Fi Networking
- 9 Zone
- Occupancy/Vacancy Sensing
- Scheduling
- Scene Control
- Daylighting
- Multi-Way Switching
- Emergency Lighting

What You Will Need

		Quantity
	GreenMAX DRC 8-Button Wireless Keypad Room Controller DRKDN-U8W	1
	8-Button Wireless Multi-Way Remote DLDNK-08W	1
	Intellect-enabled Fixture LRTH2x2-LED835UNV-LV01	36

* Note that code updates are highlighted.

Code Requirements*

2021 IECC	
• Section C405.2.1	• Occupancy Sensors
• Section C405.2.2.1	• Automatic Time Switch Control
• Section C405.2.2.2	• Interior Manual Lighting Controls
	• Light Reduction Controls
• Section C405.2.3	• Daylight Responsive Controls
• Section C405.2.3.1	• Daylight Zone Control
• Section C408.3	• Functional Testing
ASHRAE 90.1 2022	
• Section 9.4.1	• Lighting Control
• Section 9.4.1.1	• Interior Lighting Control
• Section 9.4.3	• Functional Testing
2022 Title 24, Part 6	
• Section 130.1(a)	• Area Controls
	• Manual ON/OFF
• Section 130.1(b)	• Multi-Level Controls
	• Dimming
• Section 130.1(c)	• Shut-Off Requirements
	• Occupancy Control
	• Partial-ON / Partial-OFF
• Section 130.1(d)	• Daylighting
• Section 130.1(f)	• Control Interactions
• Section 110.129(c)	• Demand Management Controls

More Application Diagrams

GreenMAX DRC 70-Zone DALI and 8-Zone Relay Plus Daylighting, Typical

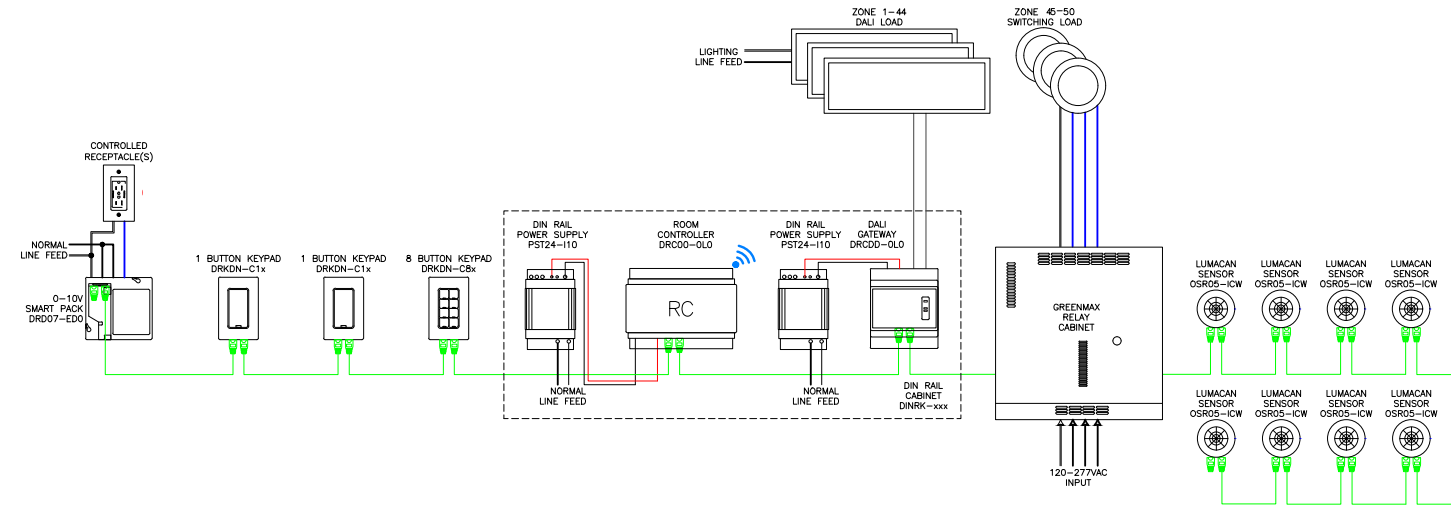

GreenMAX DRC 3-Zone 0-10V and 2-Zone Phase Control Dimming Plus Daylighting, Typical

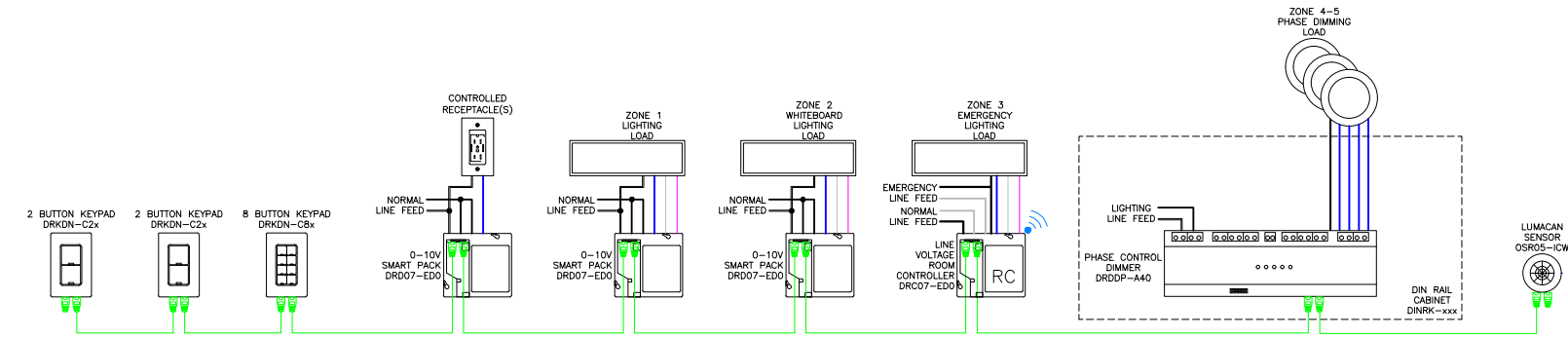

GreenMAX DRC 18-Zone Phase Control Dimming, Typical

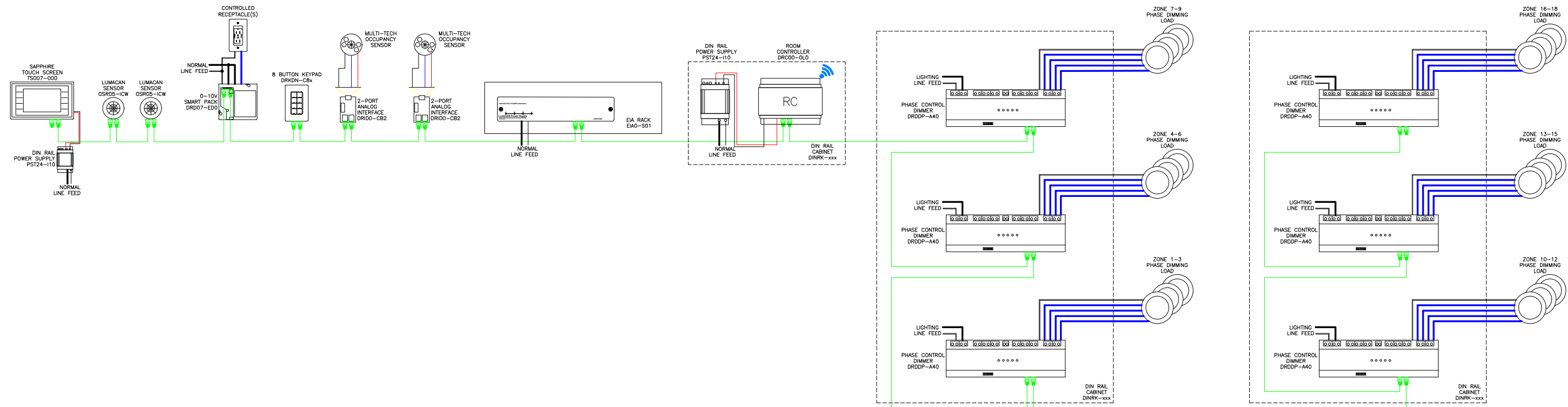

More Application Diagrams

GreenMAX DRC Hospitality Public Areas, Typical

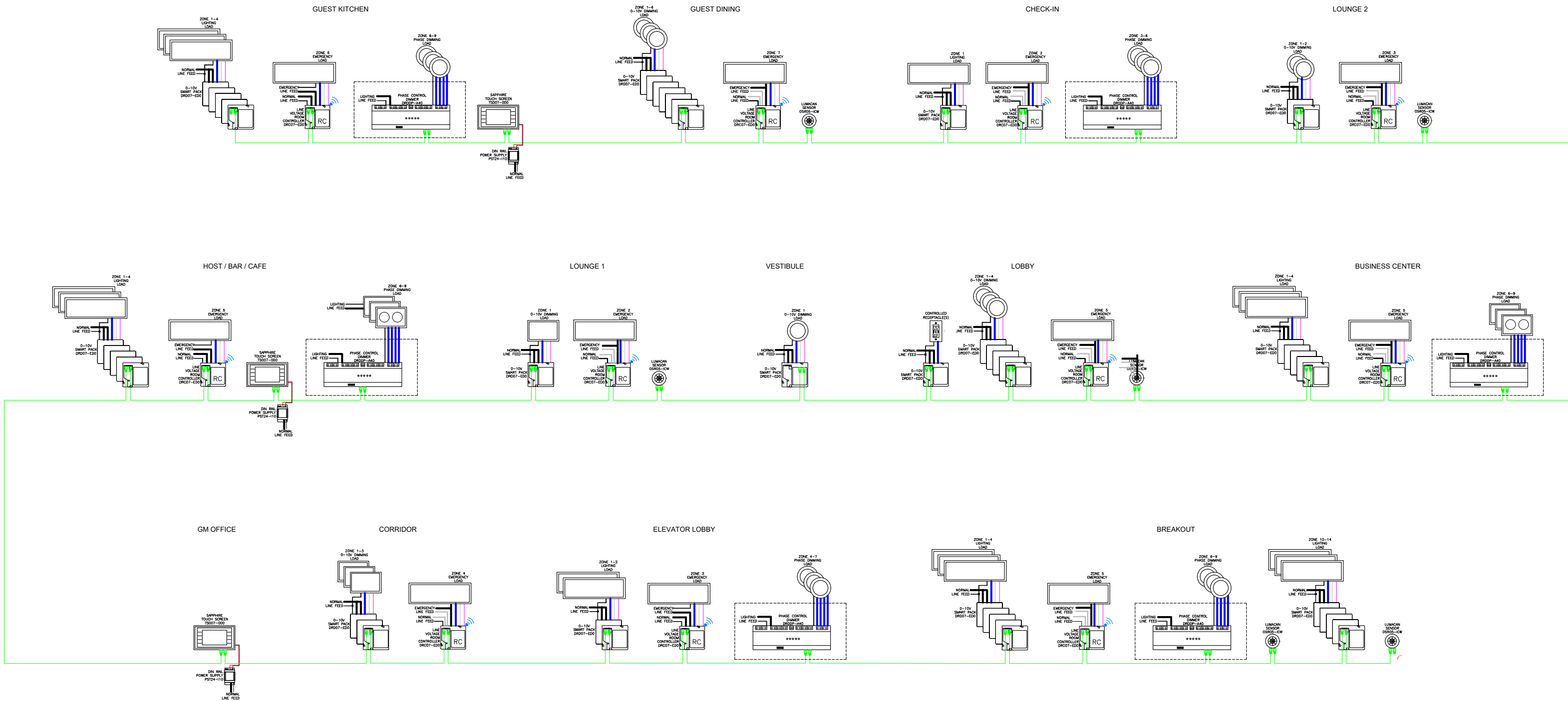

Vertical Markets

GreenMAX DRC & Grocery

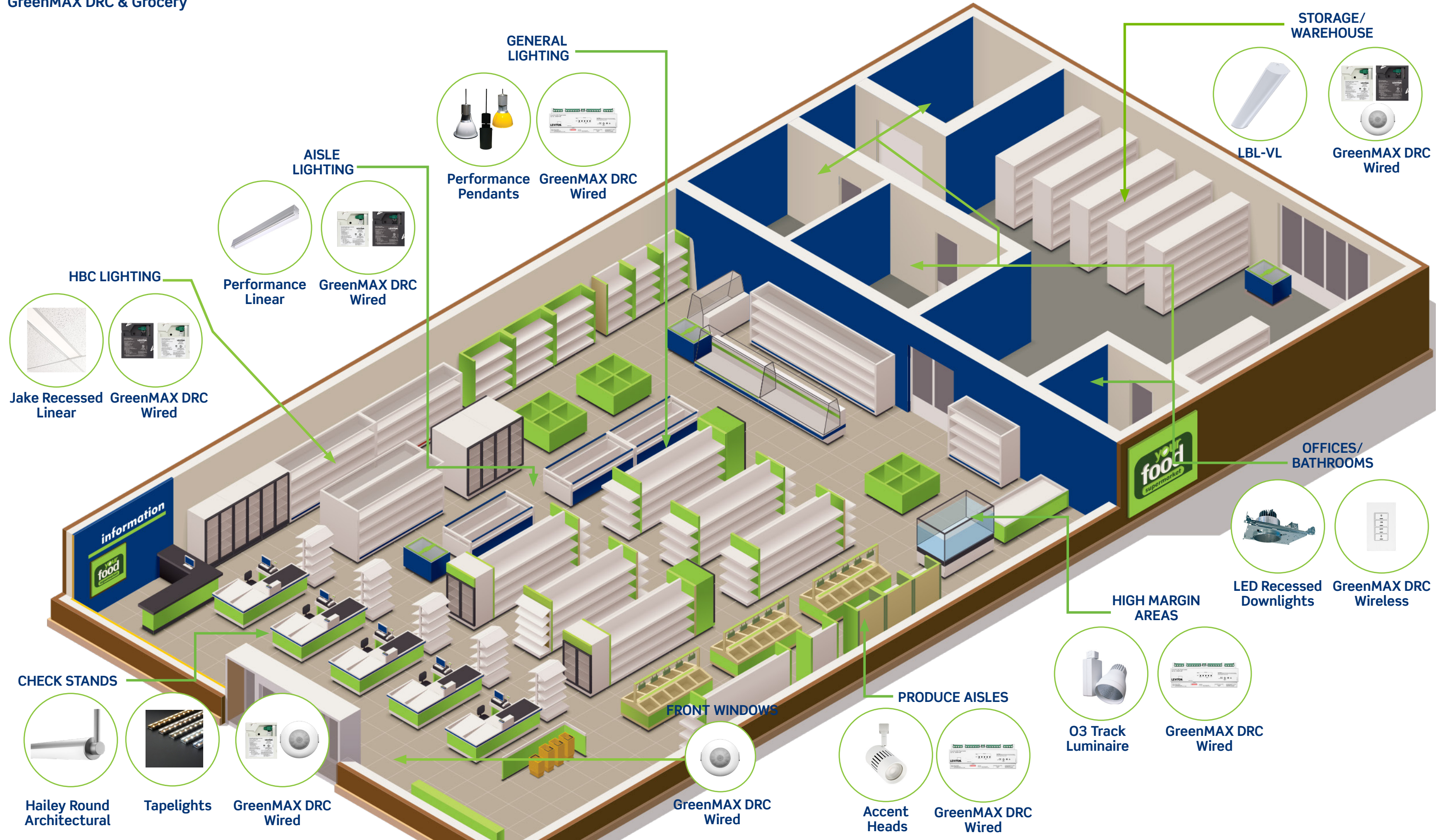

Vertical Markets

GreenMAX DRC & Healthcare





Vertical Markets

GreenMAX DRC & Hospitality

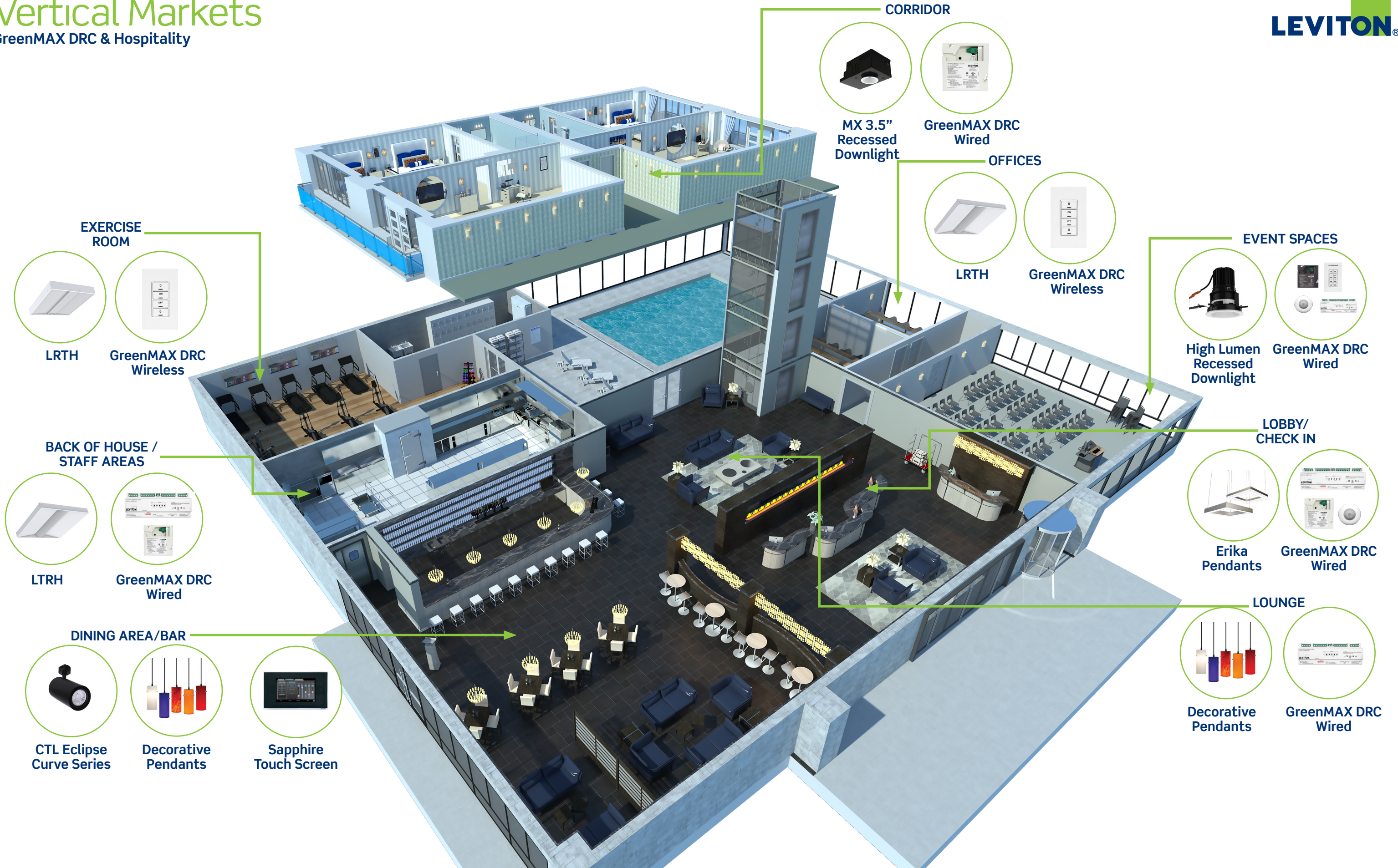

Vertical Markets

GreenMAX DRC & Office

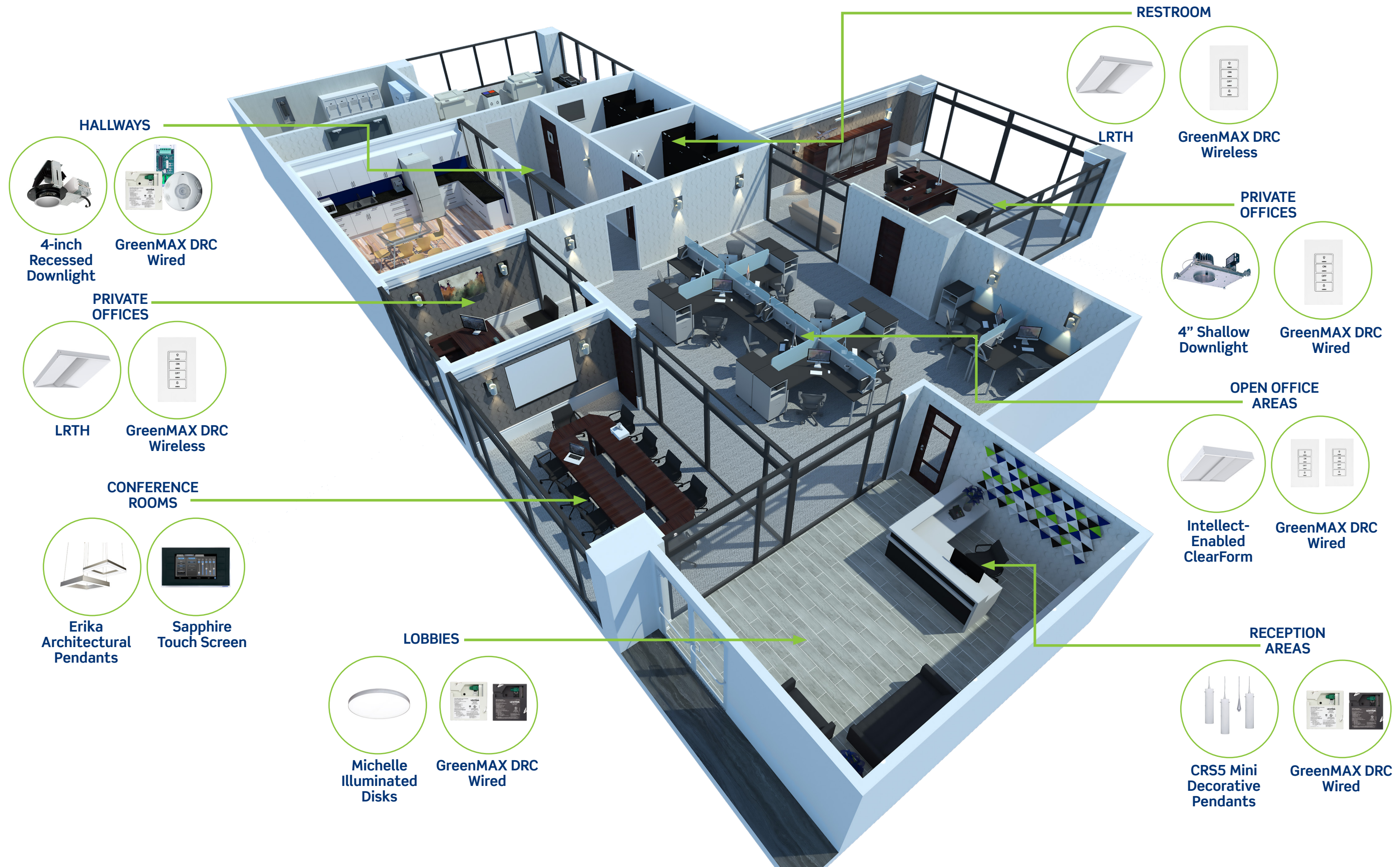

Vertical Markets

GreenMAX DRC & Retail



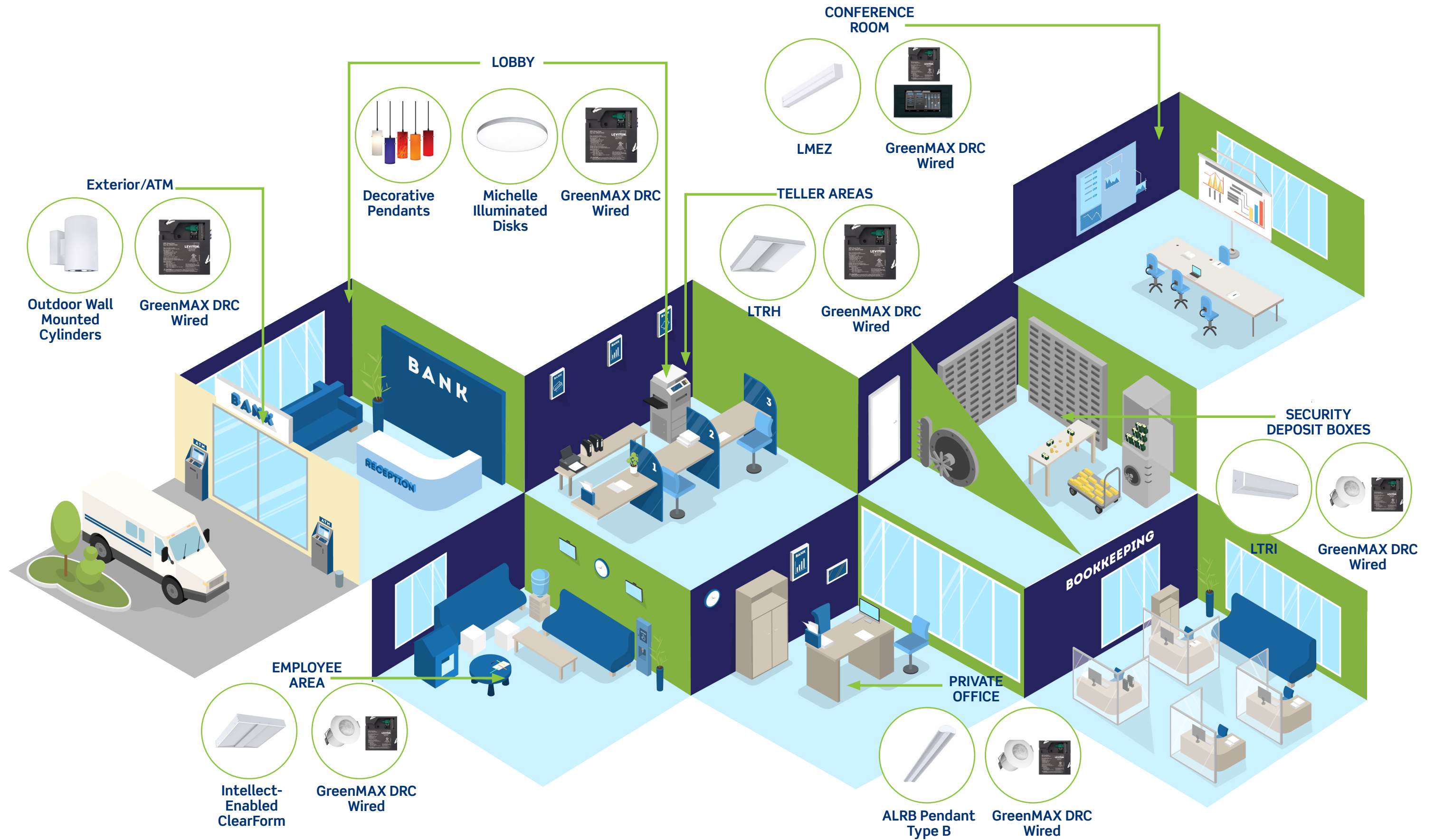

Standalone Solutions



Smart Multi-Technology Wallbox Sensors

Smart Multi-Technology Wallbox Sensors use passive infrared (PIR) and microphonics technology that “listens” for human activity in the space and keeps the lights ON when motion is detected. Microphonics does not require direct line of sight and can pick up human activity behind obstructions that PIR-only devices are unable to detect. The sensors deliver a simple sensing and dimming or switching control solution for easy energy savings, local control, and code compliance. Use the Leviton Push-to-Pair (P2P) process to create a multi-way system for up to 5 devices. Easy programming and configuration via the Smart Sensor App.

Smart Multi-Tech Wallbox Sensors				
Description	Cat. No.	Color	Rating	Coverage
Smart Multi-Technology Wallbox Sensor	ODSMT-MD*	W,I	General Purpose @ 120 V, 277 V: 20 A LED/Electronic Ballast @ 120 V, 277 V: 20 A LED/Electronic Ballast @ 120, 277 V: 10 A Standard Ballast @ 120 V, 277 V: 10 A Tungsten @ 120 V, 277 V: 6.67 A Motor @ 120 V: 1/4 HP (FLA 5.8 A) Motor @ 277 V: 1/3 HP (FLA 3.0)	180°, 1100 sq. ft. (102 sq. m.)
Smart Multi-Technology 0-10V Dimming Wallbox Sensor	ODDMT-MD*	W,I	General Purpose @ 120 V, 277 V: 10 A LED/Electronic Ballast @ 120 V: 8 A LED/Electronic Ballast @ 277 V: 5 A Standard Ballast @ 120 V, 277 V: 10 A Tungsten @ 120 V, 277 V: 6.67 A Motor @ 120 V: 1/4 HP (FLA 5.8 A) Motor @ 277 V: 1/3 HP (FLA 3.0)	
Smart Multi-Technology 24 V Dimming Wallbox Sensor	ODDMT-MLW*	W	12-24 VDC	
Smart Multi-Technology 120 V 1000 W Dimming Wallbox Sensor	ODP10-M1*	W, I	LED/Electronic Ballast @ 120 V Magnetic Ballasts @ 120 V Resistive, Tungsten @ 120 V Motor @ 120 V Not rated for use	
Smart Multi-Technology 1000 W Dimming Wallbox Sensor	ODP10-I1*	W,I	LED/CFL, Electronic Ballast @ 120 V, Magnetic Ballasts @ 120 V, Resistive Tungsten @ 120 V: 1000 W (Single Device), 680 W (Two Devices), 600 W (More Than Two Devices)	

* Replace x to indicate color: Black (B), Red (R), Gray (G), Ivory (I), Light Almond (A) and White (W).



ODSMT



ODDMT/ ODP10

Smart PIR and Multi-Tech Ceiling Mount 0-10V Dimming Room Controllers (SRC)

The Leviton Smart Ceiling Mount 0-10V Room Controller (SRC) and Smart Ceiling Mount Sensor (CMS) line simplifies advanced lighting controls by integrating several control strategies into a compact, self-contained, cost-effective, and easy-to-install and commission device. Get the same great features as the PRC and Provolt Sensors with more capabilities including true 2-zone control, Ladderless Commissioning™ using the Smart Sensor App, scheduling and more. Network up to 5 SRC and CMS devices to expand the field-of-view.

Smart PIR and Multi-Tech Ceiling Mount 0-10V Dimming Room Controllers				
Description	Cat. No.	Coverage	Color	Input Voltage, Rating
Smart Multi-Technology Ceiling Mount, 0-10V Dimming Room Controller, 1-Zone	AC705-DMW	500 sq. ft. (46.45 sq. m.)	W	120 V, 50/60 Hz 8 A, Electronic Ballast, 800 W/VA, Tungsten Ballast, 1/4 HP Motor
Smart PIR Ceiling Mount, 0-10V Dimming Room Controller, 2-Zone	ACY15-DIW	450-1500 sq. ft. (41.80-139.35 sq. m.)		
Smart Multi-Technology Ceiling Mount, 0-10V Dimming Room Controller, 2-Zone	ACY20-DMW	2000 sq. ft. (185.80 sq. m.)		

Smart PIR and Multi-Tech Ceiling Mount Switching Occupancy/Vacancy Sensors (CMS)

Smart PIR and Multi-Tech Ceiling Mount Switching Occupancy Sensors					
Description	Cat. No.	Coverage	Color	Input Voltage, Rating	
Smart Multi-Technology Ceiling Mount, Switching, 1-Zone Occupancy Sensor	ACS05-DMW	500 sq. ft. (46.45 sq. m.)	W	120 V, 50/60 Hz 8 A, Electronic Ballast, 800 W/VA, Tungsten Ballast, 1/4 HP Motor	
Smart Multi-Technology Ceiling Mount, Switching, 1-Zone Occupancy Sensor	ACS10-DMW	1000 sq. ft. (92.90 sq. m.)			
Smart Multi-Technology Ceiling Mount, Switching, 2-Zone Occupancy Sensor	ACS20-DMW	2000 sq. ft. (185.80 sq. m.)			
Smart Multi-Technology Ceiling Mount, Switching, 2-Zone Occupancy Sensor	AC205-DMW	500 sq. ft. (46.45 sq. m.)		230V, 50 Hz 6A/6AX, Electronic Ballast, Magnetic Ballast, 1200 W, VA, 1/3 HP	
Smart Multi-Technology Ceiling Mount, Switching, 2-Zone Occupancy Sensor	AC220-DMW	2000 sq. ft. (185.80 sq. m.)			
Smart PIR Ceiling Mount, Switching, 1-Zone Occupancy Sensor	ACS15-DIW	450-1500 sq. ft. (41.80-139.35 sq. m.)			277 V, 50/60 Hz 5 A, Electronic Ballast, 1200 VA, 1/3 HP Motor



Service and Support

During Every Step of the Process.

There is much more to making lighting more energy efficient than just installing a simple device or two. System design, product selection, installation and service: it all has to come together. That's where Leviton service and support options come in. We'll help you design your GreenMAX DRC Room Control system and make the right product selections so you can create a solution that does exactly what you want it to do while saving electricity, meeting codes and standards, and even garnering rebates.

It all starts with the Leviton sales representative. Our lighting control specialists are here to support you every step of the way. They can perform on-site facility audits and suggest the best GreenMAX DRC Room Control System configuration to meet your needs and preferences.

Exclusive Wealth of Resources

- **Exclusive Training**—contact your local Leviton representative to have a GreenMAX DRC expert provide training in person or online exclusively for your team
- **GreenMAX DRC Resource Library**—all of our data sheets, cookbooks, solution sheets and more in one easy-to-access place - visit www.leviton.com/greenmaxdrc
- **GreenMAX DRC Remote Support**—allows users to connect to Leviton's expert Technical Support staff via an Android, iOS, Windows or Mac device for remote troubleshooting and configuration support
- **GreenMAX DRC App**—configure and control the entire GreenMAX DRC Room Control System from the palm of your hand - download at **Apple App Store** or **Google Play**
- **ez-Learn™**—get Leviton smart from the comfort of your home or office with this exclusive 24/7 online training—go to www.leviton.com/ezlearn
- **Lighting control specialists** at your disposal
- **Field service engineers** for top-level support
- **Factory commissioning service**
- **Dedicated technical support** via phone at 800-959-6004





Leviton Manufacturing Co., Inc. Lighting & Controls

10385 SW Avery Street, Tualatin, OR 97062 **tel** 800-736-6682 **tech line** (6:00AM-4:00PM PT Mon-Fri) 800-954-6004

Leviton Manufacturing Co., Inc. Global Headquarters

201 North Service Road, Melville, NY 11747-3138 **tel** 800-323-8920 **tech line** (8:00AM-10:00PM ET Mon-Fri, 9:00AM-7:00PM ET Sat, 9:00AM-5:00PM ET Sun) 800-824-3005

Visit our website at: www.leviton.com/greenmaxdrc

©2024 Leviton Manufacturing Co. Inc. All rights reserved. Subject to change without notice.

LES-G-10439G/K24-aa
REV NOV 2024