

EV Series Plug-In Charger - 40 AMP

Cat. Nos. EV40P

Installation Manual

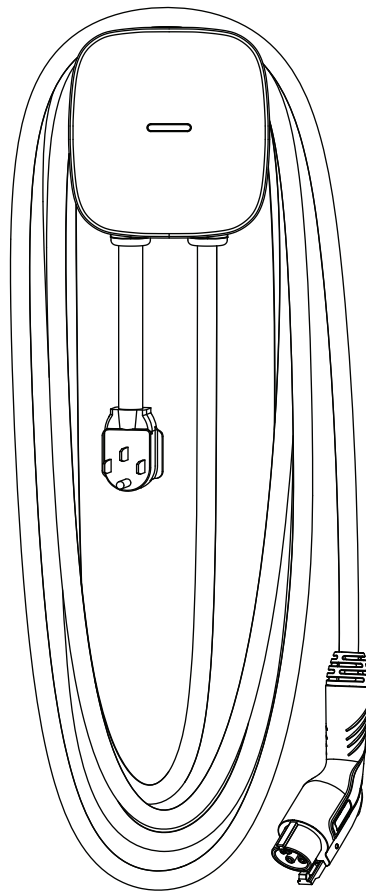

TABLE OF CONTENTS

1	Warnings	4
2	Safety and Specifications	5
3	Tools Needed	6
4	Basic Interface	7
5	Dimensions	8
6	Status Light Key	9
7	Installation	10
8	Operating Instructions	11
9	Error and Warning Messages	14
10	Maintenance and Repair	15
11	STANDARD STATEMENTS AND WARRANTY	16

1 WARNINGS

Safety Instructions

WARNINGS:

- TO AVOID FIRE, SHOCK, DEATH, OR DAMAGE TO THE CHARGER, carefully read the charging instructions in your vehicle's manual before charging and heed the following warnings:
- TO AVOID INJURY OR DEATH:
 - DO NOT put fingers into the electric vehicle connector.
 - DO NOT remove cover or attempt to open the enclosure because of risk of electric shock.
 - This device must be grounded.
 - Do not use this device with an extension cord.
- DO NOT use this product if the flexible power cord or EV cable is frayed, insulation-broken, or any other signs of damage.
- DO NOT use this product if the enclosure or the EV connector is broken, cracked, open, or shows any other indication of damage.
- This device should be supervised when used around children.
- The suitability of the use of flexible cord in accordance with CE code, part I, rule 4-012, is to be determined by the local inspection authority.
- To reduce the risk of fire, connect only to a circuit provided branch circuit over-current protection in accordance with the CSA C22.1–15 Canadian Electrical Code, Part 1 (Canada) or NOM-001-SEDE Electrical installations (utility) (Mexico) or ANSI / NFPA 70 National Electrical Code (USA).
- Be sure to preview the user manual and ensure local building and electrical codes are reviewed before installing the AC charger.
- The AC charger should be installed by a qualified technician according to the user manual and local safety regulations.

CAUTIONS:

- Use appropriate protection when connecting to the main power distribution cable
- Disconnect switch for each ungrounded conductor of AC input shall be provided by others in accordance with the National Electric Code, ANSI/NFPA70.
- The device shall be mounted at height between 2 ft. (600 mm) and 4 ft. (1200 mm) from ground.
- Please keep the charger in a clean area with low humidity. Not recommended to be installed in coastal environments with high humidity or high dust.
- Incorrect installation and testing of the charger could potentially damage either the vehicle's battery and/or the device itself. Any resulting damage is excluded from the warranty for the device
- Ensure that the charging cable is well positioned during charging so it will not be stepped on, tripped over, or subjected to damage or stress.
- The device is designed only for vehicles that are compatible with the SAE J1772 Level 2 charging standard.

Model	Output Amperage	Circuit Breaker
EV40P	40A	50A

2 SAFETY AND SPECIFICATIONS

Design Safety Standards

UL2594: Electric Vehicle Supply Equipment
UL 2231-1: Personnel Protection Systems for Electric Vehicle (EV) Supply Circuits: General Requirements
UL 2231-2: Personnel Protection Systems for Electric Vehicle (EV) Supply Circuits: Particular Requirements for Protection Devices for Use in Charging Systems
UL 2251: Plugs, Receptacles and Couplers for Electric Vehicles
UL 62: Flexible Cords and Cables
UL 991: Tests for Safety-Related Controls Employing Solid-State Devices
UL 1998: Software in Programmable Components
NFPA 70 Article 625: National Electrical Code, Electric Vehicle Charging System
UL840 (Clearance and Creepage)

Specifications

Model Name	EV40P
Rated Input Voltage	200-240 VAC
Rated Output Current	40A
Input Protection	UVP, OVP, RCD, SPD, Ground Fault Protection
Output Protection	OCP, OTP, Control Pilot Fault Protection
Output Interface	SAE J1772 AC Charging Connector
Storage Temperature	-40°F(-40°C) to + 158°F(70°C)
Operation Temperature	-22°F(-30°C) to + 122°F(50°C)
Relative Operation Humidity	95% RH Maximum
Relative Storage Humidity	95% RH Maximum
Wi-Fi Function - Wi-Fi Version	802.11 b/g/n
Cable Length	25 ft.
Protection Level	Type 3
Status Indication	Red, Green, Blue LED

3 TOOLS NEEDED

Tools required:

- Wire stripper
- Adjustable Wrench M6
- Voltmeter or digital multimeter (for measuring AC voltage at the installation site)
- Level
- Pencil or marker
- Drill

Contents Included:

#	Product Name	Quantity	Description
1	AC Charger	1	With attached input power cable and output charging cable.
2	User Manual	1	PDF version available online.
3	Wall Mounted Bracket	1	For mounting the charging station to the wall/structure.
4	M5 Anti-Theft Round Head Screws	2	For securing the charging station to the Mounting Bracket.
5	M6 Hexagonal Expansion Screws	4	For installing the Mounting Bracket to the wall/structure.
6	Standard RFID Card	2	RFID version only.
7	Admin RFID Card	1	RFID version only.
8	Allen Wrench	1	For tightening M5 Screws.
9	Corrugated Mounting Template	1	For easy drilling of 4 screws holes for wall-mounted bracket.
10	Wing Nut Screw	2	For securing the rear notch of the charger to the wall-mounted bracket.

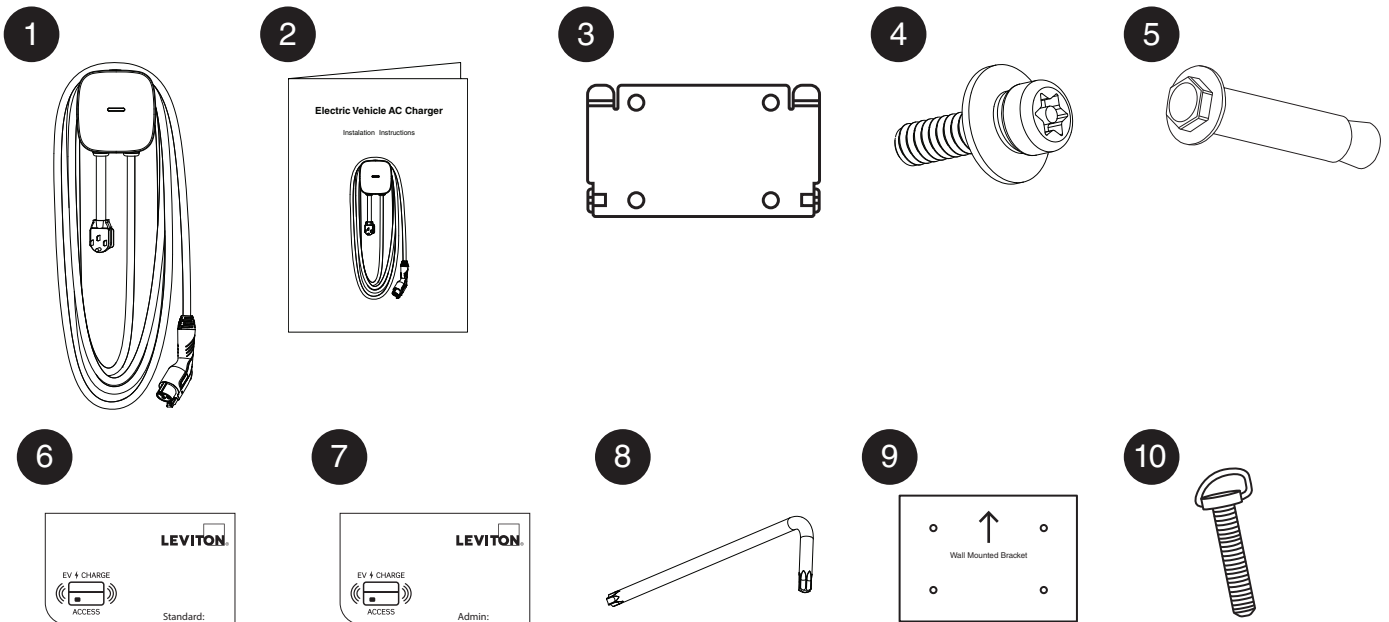

4 BASIC INTERFACE

EV40P

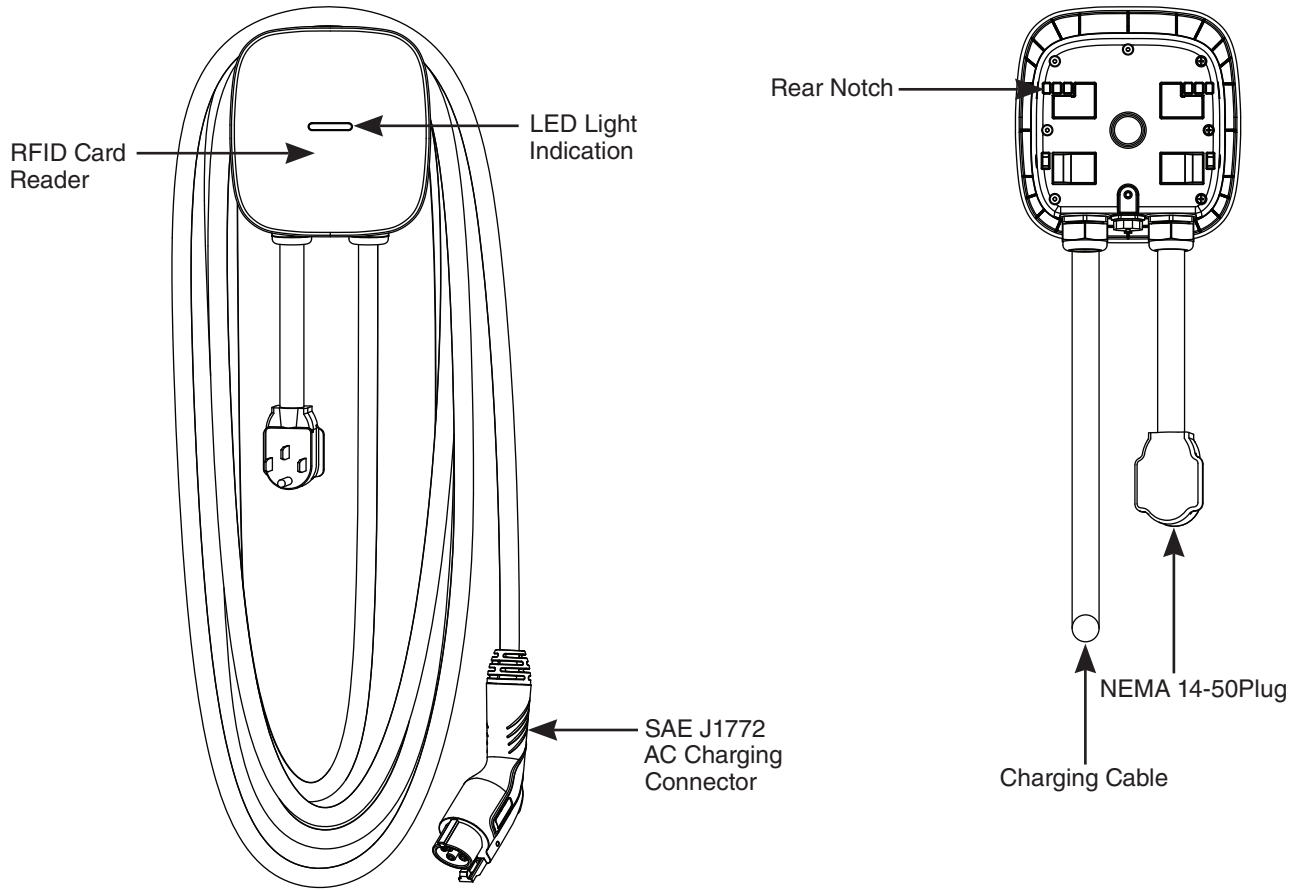

5 DIMENSIONS

Enclosure

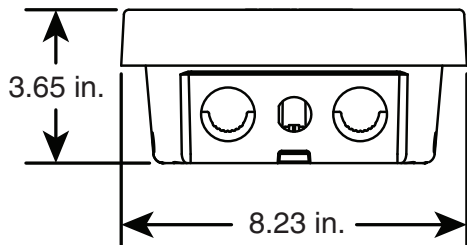
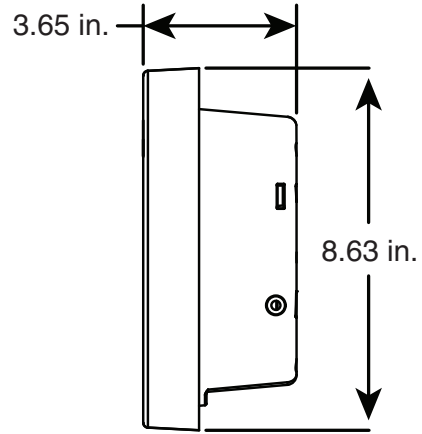
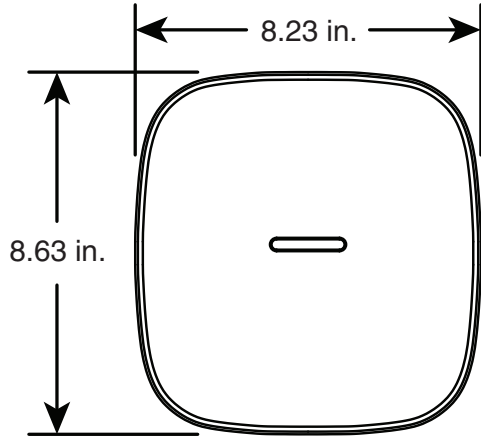



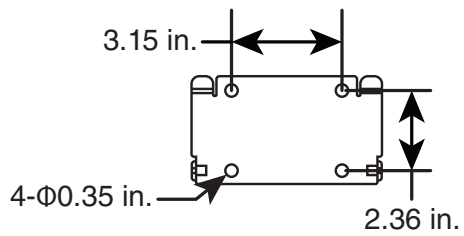

Wall-Mounted Bracket



6 STATUS LIGHT KEY

6.1 Status Description of the Charger Indication Light

Status of Charger Indication Light	
 Blue Light	Standby - Blue Light The READY light stays steady in standby mode.
 Green Light	Waiting for Charge - Green Light After the vehicle connector is connected to the vehicle inlet, the CHARGE light is constantly lit.
 Green Light Flashing	Charging - Green Light Flashing The CHARGE light flashes while charging
 Red Light	Fault - Red Light The red light is lit while fault. Please refer to section 9 “Error and Warning Messages” for detailed information.
 Blue Light Flashing	MyLeviton Setup Mode - Blue Light Flashing (EV32W, EV48W, EV80W and EV40P only)

WARNINGS:

- Be sure to preview the user manual and ensure local building and electrical codes are reviewed before installing the AC charger.
- The AC charger should be installed by a qualified technician according to the user manual and local safety regulations.
- Use appropriate protection when connecting to the main power distribution cable.
- Type B, C or D breaker with the rating current for table should be installed in the upstream AC distribution box.
- Disconnect switch for each ungrounded conductor of AC input shall be provided by others in accordance with the National Electrical Code, ANSI/NFPA 70.

7 INSTALLATION

7.1 Wall-Mounted Bracket and Charger Installation

NOTE: Ensure a NEMA 14-50 receptacle is installed within reach of the EV40P charger. Input cable length from device is 3 ft.

1. Select the appropriate mounting location with electrical capacity:
 - Ensure the owner has chosen a mounting location that allows the charging cable to reach the car's charging port while still providing slack.
 - The device must be anchored into mounting such as 2" x 4" stud or a solid wall.
 - The device shall be mounted at height between 2 ft. (600 mm) and 4 ft. (1200 mm) from ground.

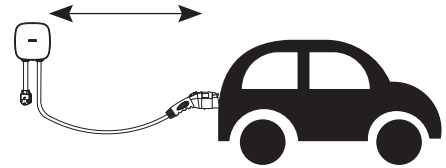

2. Drill 4 screw holes with a diameter of 0.35" and a depth of 2.05"

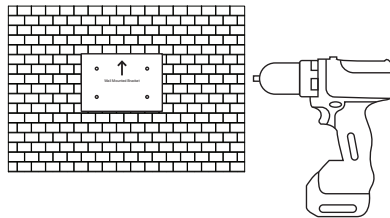

3. Use 4 Hexagonal Expansion Screws to secure the wall-mounted bracket (Use anti-theft hexagonal expansion screws) on the wall. Then level the bracket.

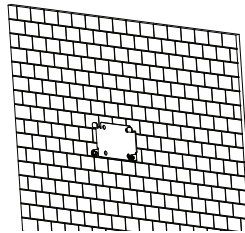

4. Align the rear notch of charger with the wall-mounted bracket and fit the screw holes of the right and left side. Tighten two wing nut screws by hand.

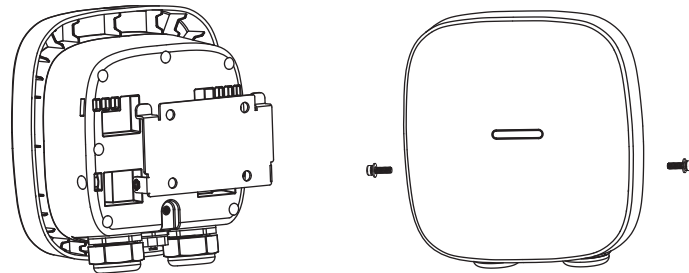

5. Plug in your EV40P to a NEMA 14-50 receptacle. Installation is complete.

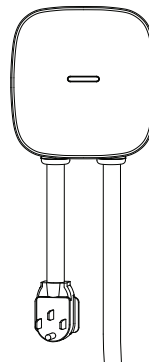

8 OPERATING INSTRUCTIONS

8.1 Operating Procedures

- User authorization
- Connect to Vehicle Charging Inlet
- Charging Message
- Charging completed

NOTE: Device may need to be activated or de-activated with RFID cards.

WARNING: This device should be supervised when used around children.

CAUTIONS:

- Please use the charger properly. Do not hit or press hard on the enclosure. If the case is damaged, please contact a professional technician.
- Do not put heavy objects on the charger to avoid danger.

NOTE: RFID access control is disabled by default on all units. See section 8.2 for operation with RFID enabled.

8 OPERATING INSTRUCTIONS

8.2 To Restrict User Activation via RFID Card

Activation and Usage

NOTE: Activation of RFID access control is **ONLY** required when access to charging will be restricted only for RFID card holders. If no restriction is required (open charging) this step is **NOT** required.

1. Identify Your Card

- All units come with 1 administrative (admin) card and 2 standard cards as marked on the cards.
- Admin cards are used to **activate** RFID access control and should be kept by charger owner.
- Standard cards are used to **enable** charging by users.

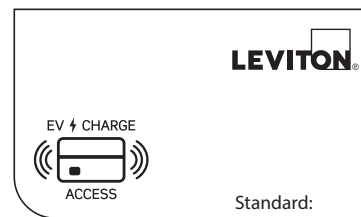
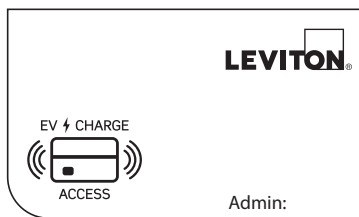

2. Activate RFID Access Control

CAUTION: Once enabled, RFID access control cannot be disabled. If you prefer to keep this as an unrestricted unit, do not activate this card.

- To enable RFID access control, hold the admin card to the RFID sensor image on the front of the charger until you hear a beep. RFID access control is now enabled.

8 OPERATING INSTRUCTIONS

3. To enable charging with RFID card(s)
- Charging can be enabled with your standard RFID cards

1. Enable charging.

TAP your RFID card to the front of the charger over the image of the RFID. The POWER light will turn solid green when the RFID card has enabled the unit to charge.

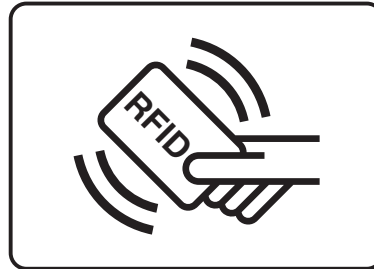

2. Start charging.

Press and hold the black button on the top of the charge plug and insert it into the inlet on your car. Charging starts automatically. The CHARGE light will flash green.

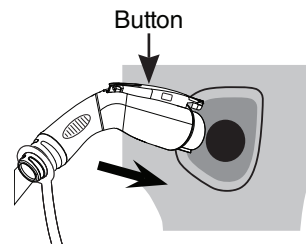

3. How to stop and restart.

To stop charging, press black button on top of charge plug to remove plug. To restart charging, tap your RFID card, press black button and reinsert.

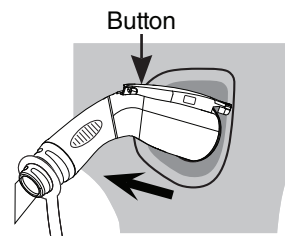

4. After charging is complete.

When charging is complete, loop charging cable over station to prevent tripping hazard.

NOTE: If the charging station is not being used for an extended period of time, it should be turned OFF.

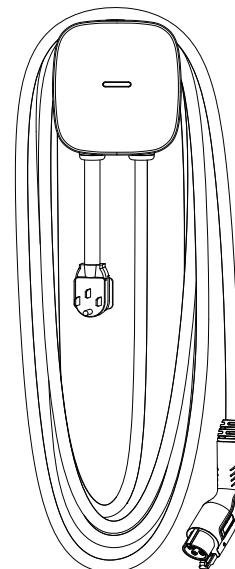

9 ERROR AND WARNING MESSAGES

Status	Blue	Green	Red	Remark
Input OVP	-	-	1 flash followed by 3 sec pause	Auto Recover
Input UVP	-	-	2 flashes followed by 3 sec pause	Auto Recover
Output OCP	-	-	3 flashes followed by 3 sec pause	Auto Recover
OTP	-	-	4 flashes followed by 3 sec pause	Auto Recover
CCID Abnormal	-	-	5 flashes followed by 3 sec pause	RCD Abnormal, Auto Recover
GMI Fault	-	-	6 flashes followed by 3 sec pause	Ground Fault, Auto Recover
Control Pilot Fault	-	-	Keep Blinking	Auto Recover
CCID Self-Test Fault	-	-	Stable Red	Contact Customer Service

10 MAINTENANCE AND REPAIR

10.1 Daily Maintenance

WARNING

- Avoid moisture or water in the charger. If there is water or moisture, it is necessary to immediately power off to avoid immediate danger, and notify professional personnel to carry out maintenance before next use.

CAUTIONS

- Use the charger properly. Do not hit or press hard on the enclosure. If it is damaged, please contact a professional technician.
- Avoid placing the charger near hot objects and at high temperature locations and away from dangerous substances such as flammable gases and corrosive materials.
- Do not put heavy objects on the charger to avoid danger.

11 STANDARD STATEMENTS AND WARRANTY

FCC STATEMENT:

This device complies with Part 15 of the FCC Rules and ISSED License-exempt RSS standard(s). Operation is subject to the following two conditions: (1) This device may not cause harmful interference, and (2) This device must accept any interference received, including interference that may cause undesired operation. Changes or modifications not expressly approved by Leviton could void the user's authority to operate the equipment.

These limits are designed to provide reasonable protection against harmful interference in a commercial installation. This equipment generates, uses and can radiate radio frequency energy and, if not installed and used in accordance with the instructions, may cause harmful interference to radio communications. However, there is no guarantee that interference will not occur in a particular installation. If this equipment does cause harmful interference to radio or television reception, which can be determined by turning the equipment off and on, the user is encouraged to try to correct the interference by one or more of the following measures:

- Reorient or relocate the receiving antenna.
- Increase the separation between the equipment and receiver.
- Connect the equipment into an outlet on a circuit different from that to which the receiver is connected.
- Consult the dealer or an experienced radio/TV technician for help.

This Class A digital apparatus complies with Canadian CAN ICES-3(A)/NMB-3(A).

FCC SUPPLIER'S DECLARATION OF CONFORMITY:

This device complies with part 15 of the FCC Rules. Operation is subject to the following two conditions: (1) This device may not cause harmful interference, and (2) this device must accept any interference received, including interference that may cause undesired operation.

TRADEMARK DISCLAIMER:

Leviton and the Leviton logo are trademarks of Leviton Manufacturing Co., Inc. Use herein of third party trademarks, service marks, trade names, brand names and/or product names are for informational purposes only, are/may be the trademarks of their respective owners; such use is not meant to imply affiliation, sponsorship, or endorsement.

Leviton Manufacturing Co., Inc.
201 North Service Road, Melville, NY 11747

Visit Leviton's website at www.leviton.com.

© 2024 Leviton Manufacturing Co., Inc. All rights reserved.

Specifications and price subject to change at any time without notice.

FOR CANADA ONLY

For warranty information and/or product returns, residents of Canada should contact Leviton in writing at **Leviton Manufacturing of Canada ULC** to the attention of the **Quality Assurance Department, 165 Hymus Blvd, Pointe-Claire (Quebec), Canada H9R 1E9** or **by telephone at 1-800-405-5320**.

LIMITED 2 YEAR WARRANTY AND EXCLUSIONS

Leviton warrants to the original consumer purchaser and not for the benefit of anyone else that this product at the time of its sale by Leviton is free of defects in materials and workmanship under normal and proper use for two years from the purchase date. Leviton's only obligation is to correct such defects by repair or replacement, at its option. **For details visit www.leviton.com or call 1-800-824-3005.** This warranty excludes and there is disclaimed liability for labor for removal of this product or reinstallation. This warranty is void if this product is installed improperly or in an improper environment, overloaded, misused, opened, abused, or altered in any manner, or is not used under normal operating conditions or not in accordance with any labels or instructions. **There are no other or implied warranties of any kind, including merchantability and fitness for a particular purpose, but if any implied warranty is required by the applicable jurisdiction, the duration of any such implied warranty, including merchantability and fitness for a particular purpose, is limited to two years. Leviton is not liable for incidental, indirect, special, or consequential damages, including without limitation, damage to, or loss of use of, any equipment, lost sales or profits or delay or failure to perform this warranty obligation.** The remedies provided herein are the exclusive remedies under this warranty, whether based on contract, tort or otherwise.

For Technical Assistance Call: 1-800-824-3005 (USA Only) or 1-800-405-5320 (Canada Only) www.leviton.com